





























**CONTENTS**  
 目錄

貨類	圖形	品名	頁碼
EDP. NO	Pictures	Name	Page
100001		12.9 級公制內六角螺絲 (杯頭) ALLOY STEEL HEX SOCKET HEAD CAP SCREW DIN912-12.9	1-4
100003		12.9 級公制內六角螺絲 (細牙) ALLOY STEEL HEX SOCKET HEAD CAP SCREW DIN912 FINE THREAD	5
100002		12.9 級全牙內六角螺絲 (杯頭) ALLOY STEEL HEX SOCKET HEAD CAP SCREW FULL THREAD DIN912-12.9	6
100004		12.9 級英制內六角螺絲 (杯頭) ALLOY STEEL HEX SOCKET HEAD CAP SCREW BS2470-12.9	7
100010		12.9 級台灣內銷標準內六角杯頭螺絲 ALLOY STEEL HEX SOCKET HEAD CAP SCREW NON STANDARD-12.9	8
100009		12.9 級公制帶墊片螺絲 (杯頭) ALLOY STEEL HEX SOCKET HEAD CAP SCREW DIN912 WITH FLAT WASHER	8
100201		8.8 級公制內六角杯頭螺絲 ALLOY STEEL HEX SOCKET HEAD CAP SCREW DIN912Gr. 8.8	9-12
100701		公制不銹鋼內六角 (杯頭) SUS HEX SOCKET HEAD CAP SCREW Ref. DIN912	13
100702		英制不銹鋼內六角螺絲 (杯頭) SUS HEX SOCKET HEAD CAP SCREW Ref. BS2470	14
100016		DIN916-45H 公制合金鋼內六角杯尾無頭螺絲 ALLOY STEEL HEX SOCKET BUTT'N HEAD SCREW DIN916, CUP POINT, Gr. 45H	15
100020		45H 英制內六角杯尾無頭螺絲 ALLOY STEEL HEX SOCKET BUTT'N HEAD SCREW BS2470, CUP POINT, Gr. 45H	16
100018		DIN914-45H 公制內六角尖端無頭螺絲 ALLOY STEEL HEX SOCKET BUTT'N HEAD SCREW DIN914, CUP POINT, Gr. 45H	17
100019		DIN913-45H 公制內六角平端無頭螺絲 ALLOY STEEL HEX SOCKET BUTT'N HEAD SCREW DIN913, CUP POINT, Gr. 45H	18
100017		DIN915-45H 公制內六角凸端無頭螺絲 ALLOY STEEL HEX SOCKET BUTT'N HEAD SCREW DIN915, CUP POINT, Gr. 45H	19
100706		公制不銹鋼杯尾無頭內六角螺絲 SUS HEX SOCKET HEAD SET SCREW	20
100707		英制不銹鋼杯尾無頭內六角螺絲 SUS HEX SOCKET HEAD SET SCREW Ref. BS2470	20
100040		10.9 級公制平頭內六角螺絲 (平杯) ALLOY STEEL HEX SOCKET FLAT HEAD SCREW DIN7991	21
100041		10.9 級英制平頭內六角螺絲 (平杯) SUS HEX SOCKET HEAD SET SCREW Ref. BS2470	22
100043		10.9 級公制梅花孔螺絲 (平杯) METRIC STAR TYPE FLAT HEAD CAP SCREW, Gr. 10.9	22
100715		公制不銹鋼平頭內六角螺絲 (平杯) SUS HEX SOCKET HEAD CAP SCREW DIN7991	23
100044		10.9 級公制半圓頭內六角螺絲 (圓杯) ALLOY STEEL HEX SOCKET BUTT'N HEAD SCREW IS07380	24
100045		10.9 級英制半圓頭內六角螺絲 (圓杯) BS ALLOY STEEL HEX SOCKET BUTT'N HEAD CAP SCREW BS 2470	25
100047		10.9 級公制半圓頭梅花孔螺絲 (圓杯) METRIC STAR TYPE BUTT'N HEAD CAP SCREW	26
100048		10.9 級公制半圓頭帶墊片螺絲 (圓杯) METRIC BUTT'N HEAD WITH WASHER SCREW	26
100718		公制不銹鋼杯圓頭內六角螺絲 (圓杯) SUS HEX SOCKET BUTT'N HEAD CAP SCREW Ref. IS07380	27
100030		12.9 級公制內六角凸肩螺絲 (塞打) ALLOY STEEL HEX SOCKET HEAD SHOULDER SCREW IS07379-12.9	28
100031		12.9 級英制內六角凸肩螺絲 (塞打) ALLOY STEEL HEX SOCKET HEAD SHOULDER SCREW BS2470-12.9	29
100055/100056		12.9 級 DIN933/931 合金鋼高強度外六角螺絲 HEXAGON BOLT Gr. 12.9 DIN933/931	30-31
100060		帶墊片外六角組合螺絲 HEXAGON BOLT WITH WASHER	31
100102		8 級 UNC 英制內六角螺絲 (杯頭) ALLOY STEEL HEX SOCKET HEAD CAP SCREW ASME 18.3-12.9UNC	32



規 範 According To	DIN912-1983			
強度區分 Strength Grade	12.9	10.9	8.8	
			d ≤ 16	d > 16
強 度 Hardness	HRC 39-44	HRC 32-39	HRC 22-32	HRC 23-34
抗拉強度 Tensile Strength	1220N/mm <sup>2</sup>	1040N/mm <sup>2</sup>	800N/mm <sup>2</sup>	830N/mm <sup>2</sup>
材 質 Material	Alloy steel		Carbon Steel	
表面處理 Surface Treatment	Black Oxide			
螺紋等級 Class of thread	5g6g	6g		

UNIT: mm

螺紋規格 d	M1.6	M2	M2.5	M3	M4	M5	M6	M8	
P	粗牙	0.35	0.4	0.45	0.5	0.7	0.8	1	1.25
	細牙								1
b	參考尺寸	15	16	17	18	20	22	24	28
dk	1) Max.	3	3.8	4.5	5.5	7	8.5	10	13
	2) Max.	3.14	3.98	4.68	5.68	7.22	8.72	10.22	13.27
	Min.	2.86	3.62	4.32	5.32	6.78	8.28	9.78	12.73
da	Max.	2	2.6	3.1	3.6	4.7	5.7	6.8	9.2
ds	Max.	1.6	2	2.5	3	4	5	6	8
	Min.	1.46	1.86	2.36	2.86	3.82	4.82	5.82	7.78
e	Min.	1.73	1.73	2.30	2.87	3.44	4.58	5.72	6.86
f	Max.	0.34	0.51	0.51	0.51	0.60	0.60	0.68	1.02
k	Max.	1.6	2	2.5	3	4	5	6	8
	Min.	1.46	1.86	2.36	2.86	3.82	4.82	5.70	7.64
r	Min.	0.1	0.1	0.1	0.1	0.2	0.2	0.25	0.4
s	公稱尺寸	1.5	1.5	2	2.5	3	4	5	6
	Min.	1.52	1.52	2.02	2.52	3.02	4.02	5.02	6.02
	Max.	1.560	1.560	2.060	2.580	3.080	4.095	5.140	6.140
t	Min.	0.7	1	1.1	1.3	2	2.5	3	4
v	Max.	0.16	0.2	0.25	0.3	0.4	0.5	0.6	0.8
dw	Min.	2.72	3.48	4.18	5.07	6.53	8.03	9.38	12.33
w	Min.	0.55	0.55	0.85	1.15	1.4	1.9	2.3	3.0

說明: 1) 指普通頭部。 2) 指滾花頭部和圓周帶印記的頭部  
Illustration: 1) Nominal Head. 2) Knurled Head

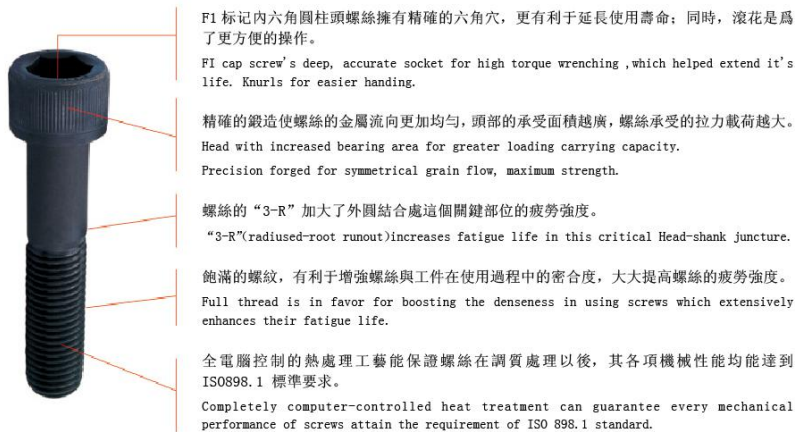

公制內六角圓柱頭螺絲  
METRIC HEXAGON SOCKET HEAD CAP SCREWS

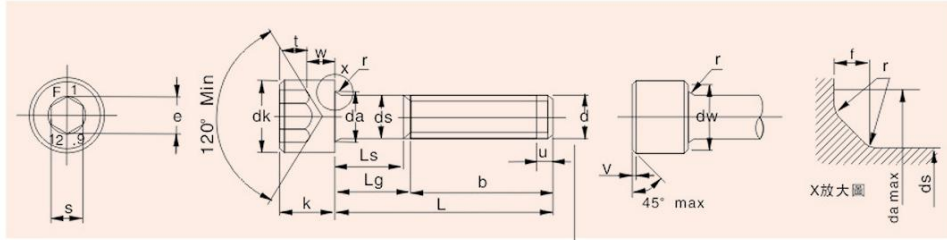

UNIT: mm

螺紋規格 d		M10	M12	M14	M16	M18	M20	M22	M24
p	粗牙	1.5	1.75	2	2	2.5	2.5	2.5	3
	細牙	1.25	1.25	1.5	1.5		1.5		
b	參考尺寸	32	36	40	44	48	52	56	60
dk	1) Max.	16	18	21	24	27	30	33	36
	2) Max.	16.27	18.27	21.33	24.33	27.33	30.33	33.39	36.39
	Min.	15.73	17.73	20.67	23.67	26.67	29.67	32.61	35.61
da	Max.	11.2	13.7	15.7	17.7	20.2	22.4	24.4	26.4
	Min.	10	12	14	16	18	20	22	24
ds	Max.	9.78	11.73	13.73	15.73	17.73	19.67	21.67	23.67
	Min.	9.15	11.43	13.72	16	16	19.44	19.44	21.73
e	Max.	1.02	1.87	1.87	1.87	1.87	2.04	2.04	2.04
k	Max.	10	12	14	16	18	20	22	24
	Min.	9.64	11.57	13.57	15.57	17.57	19.48	21.48	23.48
r	Max.	0.4	0.6	0.6	0.6	0.6	0.8	0.8	0.8
	Min.	8	10	12	14	14	17	17	19
s	公稱尺寸	8	10	12	14	14	17	17	19
	Min.	8.025	10.025	12.032	14.032	14.032	17.05	17.05	19.065
	Max.	8.175	10.175	12.212	14.212	14.212	17.23	17.23	19.275
t	Max.	5	6	7	8	9	10	11	12
v	Max.	1	1.2	1.4	1.6	1.8	2	2.2	2.4
	Min.	15.33	17.23	20.17	23.17	25.87	28.87	31.81	34.81
dw	Max.	4	4.8	5.8	6.8	7.8	8.6	9.4	10.4
w	Max.								



準確地控制六角穴的尺寸，保證與扳手達到最佳配合。  
Well-controlled dimension of screws to warrant its best assort with the wrenches.



準確控制頭部的鍛造，統一的未經損害的金屬流向使頭部更堅固，減少底平面這個重要部位的失誤，增強抗疲勞強度。  
Controlled head forging, uniform and unbroken grain flow make heads stronger; minimizes failure in the important fillet area; improves fatigue strength.



牙紋的飽和度高，能增強螺絲的抗剪力與抗疲勞強度，防止脫模。  
Contour-following flow lines offer extra shear strength to thread and high fatigue resistances, avoid being stripped.



規 範	According To	ASME B 18.3-1998
材 質	Material	Alloy Steel
強 度	Hardness	HRC 39-45
螺紋種類	Type of Thread	ANSI Bl. 1 UNC, UNF
螺紋等級	Class of thread	#6 Through 1 in. -3A
		Over 1 in. -2A
表面處理	Surface Treatment	Black Oxide

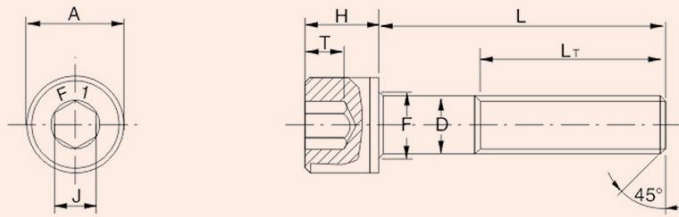

UNIT: INCH

Nominal Size or Basic Screw Diameter	D		A		H		J		T	F		L <sub>T</sub>
	Body Diameter		Head Diameter		Head Height		Hexagon Socket Size		Key Engagement	Fillet Junction Diameter at Bearing Surface		Thread Length Basic.
	Max.	Min.	Max.	Min.	Max.	Min.	Nom.	Min.	Max.	Min.		
#4 0.1120	0.1120	0.1075	0.183	0.176	0.112	0.108	3/32	0.094	0.051	0.130	0.117	0.75
#6 0.1380	0.1380	0.1329	0.226	0.218	0.138	0.134	7/64	0.109	0.064	0.158	0.144	0.75
#8 0.1640	0.1640	0.1585	0.270	0.262	0.164	0.159	9/64	0.141	0.077	0.188	0.172	0.88
#10 0.1900	0.1900	0.1840	0.312	0.303	0.190	0.185	5/32	0.156	0.090	0.218	0.202	0.88
1/4 0.2500	0.2500	0.2435	0.375	0.365	0.250	0.244	3/16	0.188	0.120	0.278	0.261	1.00
5/16 0.3125	0.3125	0.3053	0.469	0.457	0.312	0.306	1/4	0.250	0.151	0.347	0.329	1.12
3/8 0.3750	0.3750	0.3678	0.562	0.550	0.375	0.368	5/16	0.312	0.182	0.415	0.397	1.25
7/16 0.4375	0.4375	0.4294	0.656	0.642	0.438	0.430	3/8	0.375	0.213	0.484	0.465	1.38
1/2 0.5000	0.5000	0.4919	0.750	0.735	0.500	0.492	3/8	0.375	0.245	0.552	0.531	1.50
5/8 0.6250	0.6250	0.6163	0.938	0.921	0.625	0.616	1/2	0.500	0.307	0.689	0.664	1.75
3/4 0.7500	0.7500	0.7406	1.125	1.107	0.750	0.740	5/8	0.625	0.370	0.828	0.800	2.00
7/8 0.8750	0.8750	0.8647	1.312	1.293	0.875	0.864	3/4	0.750	0.432	0.963	0.932	2.25
1 1.0000	1.0000	0.9886	1.500	1.479	1.000	0.988	3/4	0.750	0.495	1.100	1.068	2.50



英制內六角圓柱頭螺絲  
BS HEXAGON SOCKET HEAD CAP SCREWS



規 範	According To	Bs 2470-1973
材 質	Material	Alloy Steel
強 度	Hardness	HRC 38-45
螺紋種類	Type of Thread	JIS B 0206 (Whitworth Coarse)
螺紋等級	Class of thread	JIS B 0210 Class 2 (With)
表面處理	Surface Treatment	Black Oxide

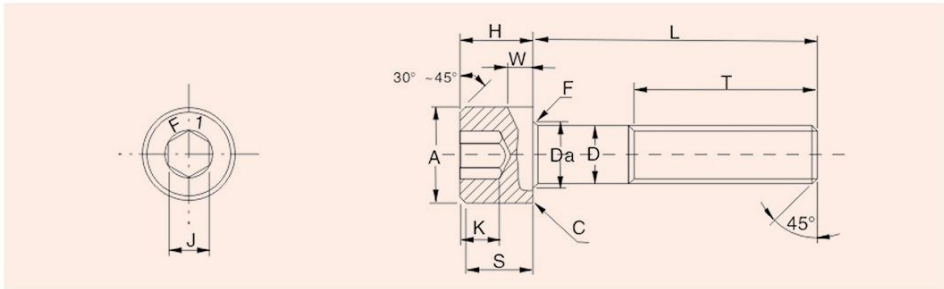

UNIT: INCH

Nominal Size	D		A		H		S	J	K	W	F	Da	C	T
	Body Diameter		Head Diameter		Head Height		Head Size Height	Hexagon Socket	Key Engagement	Wall Thickness	Fillet Radius		Chamfer or Radius	Thread Length
	Max.	Min.	Max.	Min.	Max.	Min.	Min.	Nom.	Min.	Min.	Min.	Max.	Max.	Min.
1/8	0.1240	0.1200	0.2189	0.210	0.1252	0.121	0.111	3/32	0.059	0.046	0.006	0.126	0.004	0.625
5/32	0.1560	0.1500	0.250	0.242	0.1607	0.156	0.144	1/8	0.0767	0.055	0.007	0.181	0.045	0.750
3/16	0.1875	0.1815	0.312	0.303	0.187	0.182	0.168	5/32	0.089	0.065	0.009	0.2155	0.005	0.875
1/4	0.2500	0.2435	0.375	0.365	0.250	0.244	0.225	3/16	0.120	0.095	0.009	0.2780	0.008	1.000
5/16	0.3125	0.3053	0.437	0.425	0.312	0.306	0.281	7/32	0.151	0.119	0.012	0.3465	0.008	1.250
3/8	0.3750	0.3678	0.562	0.550	0.375	0.368	0.337	5/16	0.182	0.143	0.015	0.4150	0.008	1.250
7/16	0.4375	0.4294	0.625	0.611	0.437	0.430	0.394	5/16	0.213	0.166	0.018	0.4835	0.010	1.375
1/2	0.5000	0.4919	0.750	0.735	0.500	0.492	0.450	3/8	0.245	0.190	0.020	0.5520	0.010	1.500
5/8	0.6250	0.6163	0.875	0.858	0.625	0.616	0.562	1/2	0.307	0.238	0.024	0.6890	0.010	1.750
3/4	0.7500	0.7406	1.000	0.982	0.750	0.740	0.675	9/16	0.370	0.285	0.030	0.8280	0.010	2.000
7/8	0.8750	0.8647	1.125	1.105	0.875	0.864	0.787	9/16	0.432	0.333	0.034	0.9630	0.015	2.250
1	1.0000	0.9886	1.312	1.291	1.0000	0.988	0.900	5/8	0.495	0.380	0.040	1.1000	0.015	2.500





規 範 According To	DIN931/933			
強度等級 Strength Class	12.9	10.9	8.8	
			d ≤ 16	d > 16
硬 度 Hardness	HRC 39-44	HRC 32-39	HRC 22-32	HRC 23-34
材 質 Material	Alloy Steel		Carbon Steel	
表面處理 Surface Treatment	Black Oxide			

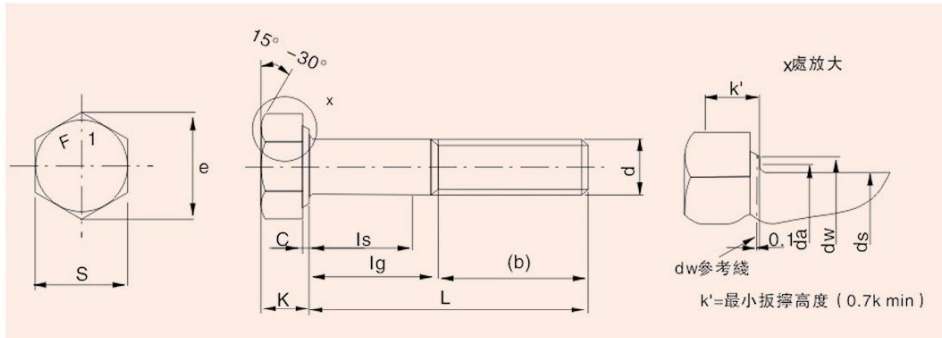

UNIT: mm

Thread Size (d)	p	ds		da	dw	e	k		r	s	
		Max.	Min.	Max.	Min.	Min.	Nominal Size	Tolerance	Min.	Nominal Size	Min.
M3	0.50	3	2.86	3.6	4.6	6.01	2.00	±0.12	0.10	5.5	5.32
M4	0.70	4	3.82	4.7	5.9	7.66	2.80	±0.12	0.20	7.0	6.78
M5	0.80	5	4.82	5.7	6.9	8.79	3.50	±0.15	0.20	8.0	9.78
M6	1.00	6	5.82	6.8	8.9	11.05	4.00	±0.15	0.25	10.0	9.78
M8	1.25	8	7.78	9.2	11.6	14.38	5.30	±0.15	0.40	13.0	12.73
M10	1.50	10	9.78	11.2	15.6	18.09	6.40	±0.18	0.40	17.0	16.73
M12	1.75	12	11.73	13.7	17.4	21.10	7.50	±0.18	0.60	19.0	18.67
M16	2.00	16	15.73	17.7	22.5	26.75	10.00	±0.18	0.60	24.0	23.67
M20	2.50	20	19.67	22.4	28.2	33.53	12.50	±0.22	0.80	30.0	29.67
M24	3.00	24	23.67	26.4	33.6	39.98	15.00	±0.22	0.80	36.0	35.38
M30	3.50	30	29.48	33.4	42.7	50.85	18.70	—	1.00	46.0	55.00
M36	4.00	36	35.38	39.4	51.1	60.79	22.50	—	1.00	55.0	53.80

公制圓頭內六角螺絲  
METRIC HEXAGON SOCKET BUTTON HEAD CAP SCREWS



規 範 According To	ISO7380-1997		
強度區分 Strength Grade	12.9		10.9
硬 度 Hardness	HRC39-44		HRC32-39
材 質 Material	Alloy Steel		
螺紋等級 Class of thread	5g 6g		6g
表面處理 Surface Treatment	Black Oxide		

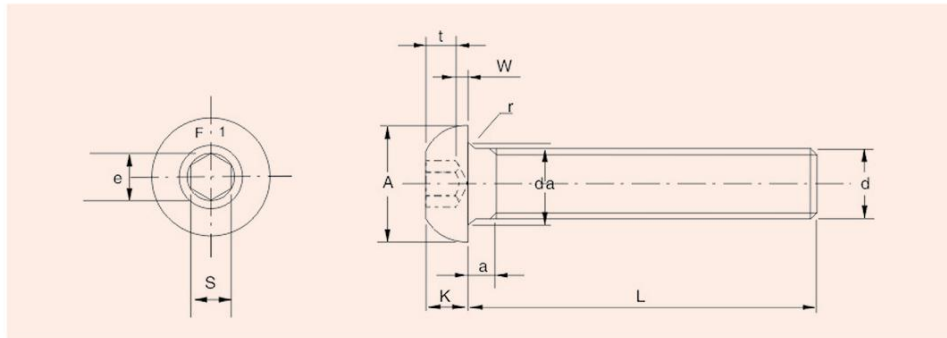

UNIT: mm

Thread Size (d)	p	a		da	A		e	K		r	S			t	w
		Max.	Min.	Max.	Max.	Min.	Ref.	Max.	Min.	Min.	Nom.	Max.	Min.	Min.	Min.
M3	0.50	1.0	0.50	3.6	5.7	5.40	2.30	1.65	1.40	0.10	2.0	2.045	2.020	1.04	0.20
M4	0.70	1.4	0.70	4.7	7.6	7.24	2.87	2.20	1.95	0.20	2.5	2.560	2.520	1.30	0.30
M5	0.80	1.6	0.80	5.7	9.5	9.14	3.44	2.75	2.50	0.20	3.0	3.080	3.020	1.56	0.38
M6	1.00	2.0	1.00	6.8	10.5	10.07	4.58	3.30	3.00	0.25	4.0	4.095	4.020	2.08	0.74
M8	1.25	2.5	1.25	9.2	14.0	13.57	5.72	4.40	4.10	0.40	5.0	5.095	5.020	2.60	1.05
M10	1.50	3.0	1.50	11.2	17.5	17.07	6.86	5.50	5.20	0.40	6.0	6.095	6.020	3.12	1.45
M12	1.75	3.5	1.75	13.7	21.0	20.48	9.15	6.60	6.24	0.60	8.0	8.115	8.025	4.16	1.63
M16	2.00	4.0	2.00	17.7	28.0	27.48	11.43	8.80	8.44	0.60	10.0	10.115	10.020	5.20	2.25





規 範 According To	DIN7991-1986	
強度區分 Strength Grade	12.9	10.9
硬 度 Hardness	HRC39-44	HRC32-39
材 質 Material	Alloy Steel	
螺紋等級 Class of thread	5g 6g	6g
表面處理 Surface Treatment	Black Oxide	

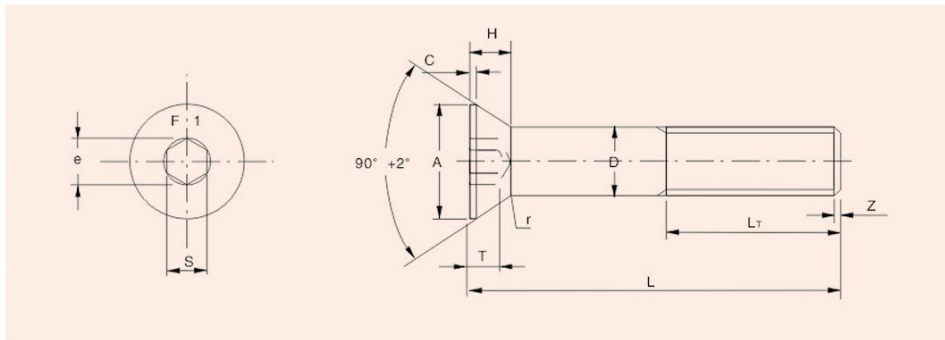

UNIT: mm

Thread Size (d)	Thread Pitch	Nominal Size		A		H	C	S		e	T		r	Z
		Max.	Min.	Max.	Min.	Max.	Reference	Max.	Min.	Approx	Max.	Min.	Min.	Approx
		Nominal Size		Nominal Size		Nominal Size		Nominal Size						
M3	0.50	3	2.86	6	5.70	1.7	0.2	2	+0.10 +0.02	2.30	1.2	0.95	0.1	0.6
M4	0.70	4	3.82	8	7.64	2.3	0.3	2.5	+0.10 +0.02	2.87	1.8	1.55	0.2	0.8
M5	0.80	5	4.82	10	9.64	2.8	0.3	3	+0.10 +0.02	3.44	2.3	2.05	0.2	0.9
M6	1.00	6	5.82	12	11.57	3.3	0.3	4	+0.10 +0.02	4.58	2.5	2.25	0.3	1.0
M8	1.25	8	7.78	16	15.57	4.4	0.4	5	+0.14 +0.02	5.72	3.5	3.20	0.5	1.5
M10	1.50	10	9.78	20	19.48	5.5	0.5	6	+0.14 +0.02	6.86	4.4	4.10	0.5	1.5
M12	1.75	12	11.73	24	23.48	6.5	0.5	8	+0.175 +0.025	9.15	4.6	4.30	1.0	2.0
M16	2.00	16	15.73	30	29.48	7.5	0.5	10	+0.175 +0.025	11.43	5.3	5.00	1.0	2.0

貨類: 100001

DIN912 公制合金鋼 12.9 級內六角螺絲 (杯頭)

ALLOY STEEL HEX SOCKET HEAD CAP SCREW DIN912-12.9



貨號	規格	售價	貨號	規格	售價	貨號	規格	售價	貨號	規格	售價	貨號	規格	售價
CODE	SIZE	RMB/1000PCS	CODE	SIZE	RMB/1000PCS	CODE	SIZE	RMB/1000PCS	CODE	SIZE	RMB/1000PCS	CODE	SIZE	RMB/1000PCS
M8-1.5			M10-1.50			M12-1.75			M14-2.0			M14-2.0		
080230	230	11000	100170	170	4400	120105	105	2000	140065	65	1850	140370	370	41000
080240	240	12000	100180	180	5000	120110	110	2000	140070	70	1950	140380	380	42000
080250	250	13000	100190	190	5300	120115	115	2100	140075	75	2050	140390	390	45000
080260	260	14000	100200	200	6200	120120	120	2100	140080	80	2200	140400	400	46000
080270	270	15000	100210	210	12000	120125	125	2300	140085	85	2400	M16-2.0		
080280	280	16000	100220	220	13000	120130	130	2300	140090	90	2400	160025	25	1450
080290	290	17000	100230	230	14000	120135	135	2450	140095	95	2600	160030	30	1450
080300	300	18000	100240	240	15000	120140	140	2450	140100	100	2600	160035	35	1550
M10-1.50			100250	250	16000	120145	145	2600	140105	105	2900	160040	40	1650
100016	16	430	100260	260	17000	120150	150	2600	140110	110	2900	160045	45	1800
100020	20	430	100270	270	18000	120160	160	3600	140115	115	3100	160050	50	1950
100022	22	460	100280	280	19000	120170	170	4000	140120	120	3100	160055	55	2050
100025	25	460	100290	290	20000	120180	180	4500	140125	125	3400	160060	60	2200
100030	30	500	100300	300	21000	120190	190	4700	140130	130	3400	160065	65	2400
100035	35	550	100310	310	23000	120200	200	5000	140135	135	3600	160070	70	2550
100040	40	600	100320	320	24000	120210	210	10000	140140	140	3600	160075	75	2650
100045	45	660	100330	330	25000	120220	220	11000	140145	145	3800	160080	80	2800
100050	50	720	100340	340	26000	120230	230	12000	140150	150	3800	160085	85	3100
100055	55	770	100350	350	27000	120240	240	13000	140160	160	4200	160090	90	3100
100060	60	830	M12-1.75			120250	250	14000	140170	170	4400	160095	95	3300
100065	65	880	120016	16	640	120260	260	15000	140180	180	5000	160100	100	3300
100070	70	950	120020	20	640	120270	270	16000	140190	190	6500	160105	105	3600
100075	75	1000	120022	22	660	120280	280	18000	140200	200	7000	160110	110	3600
100080	80	1070	120025	25	660	120290	290	19000	140210	210	12000	160115	115	3900
100085	85	1160	120030	30	730	120300	300	20000	140220	220	13000	160120	120	3900
100090	90	1200	120035	35	780	120310	310	23000	140230	230	14000	160125	125	4200
100095	95	1320	120040	40	850	120320	320	25000	140240	240	15000	160130	130	4200
100100	100	1320	120045	45	930	120330	330	27000	140250	250	16000	160135	135	4400
100105	105	1500	120050	50	1000	120340	340	29000	140260	260	18000	160140	140	4400
100110	110	1500	120055	55	1100	120350	350	31000	140270	270	19000	160145	145	4900
100115	115	1700	120060	60	1200	M14-2.0			140280	280	20000	160150	150	4900
100120	120	1700	120065	65	1250	140025	25	1100	140290	290	21000	160160	160	5200
100125	125	1800	120070	70	1350	140030	30	1100	140300	300	22000	160165	165	5700
100130	130	1800	120075	75	1400	140035	35	1200	140310	310	30000	160170	170	5700
100135	135	1900	120080	80	1500	140040	40	1300	140320	320	33000	160180	180	7500
100140	140	1900	120085	85	1600	140045	45	1400	140330	330	34000	160190	190	8100
100145	145	2000	120090	90	1600	140050	50	1500	140340	340	35000	160200	200	8600
100150	150	2000	120095	95	1800	140055	55	1600	140350	350	36000	160210	210	11500
100160	160	4100	120100	100	1800	140060	60	1750	140360	360	38000	160220	220	12500



公制內六角杯頭螺絲 (12.9 級)  
HEX SOCKET HEAD CAP SCREW



貨類: 100001

DIN912 公制合金鋼 12.9 級內六角螺絲 (杯頭)

ALLOY STEEL HEX SOCKET HEAD CAP SCREW DIN912-12.9



貨號	規格	售價	貨號	規格	售價	貨號	規格	售價	貨號	規格	售價	貨號	規格	售價
CODE	SIZE	RMB/1000PCS	CODE	SIZE	RMB/1000PCS	CODE	SIZE	RMB/1000PCS	CODE	SIZE	RMB/1000PCS	CODE	SIZE	RMB/1000PCS
M16-2.0			M18-2.5			M20-2.5			M20-2.5			M22-2.5		
160230	230	13500	180110	110	6700	200070	70	4900	200480	480	85000	220320	320	56000
160240	240	14500	180120	120	7200	200075	75	5200	200500	500	90000	220330	330	59000
160250	250	17000	180130	130	7900	200080	80	5600	M22-2.5			220340	340	62000
160260	260	19000	180140	140	8400	200085	85	6000	220030	30	6900	220350	350	64000
160270	270	20000	180150	150	8900	200090	90	6000	220035	35	6900	220360	360	67000
160280	280	21000	180160	160	10500	200095	95	6600	220040	40	6900	220370	370	72000
160290	290	22000	180170	170	11500	200100	100	6600	220045	45	6900	220380	380	76000
160300	300	23000	180180	180	14000	200110	110	7000	220050	50	6900	220390	390	81000
160310	310	30000	180190	190	15000	200120	120	7400	220055	55	7300	220400	400	84000
160320	320	32000	180200	200	17000	200130	130	8100	220060	60	7700	M24-3.0		
160330	330	34000	180210	210	18000	200140	140	8800	220065	65	8100	240030	30	8200
160340	340	36000	180220	220	19000	200150	150	9300	220070	70	8400	240035	35	8200
160350	350	37000	180230	230	20000	200160	160	11000	220075	75	8900	240040	40	8200
160360	360	39000	180240	240	22000	200170	170	12000	220080	80	9100	240045	45	8200
160370	370	41000	180250	250	24000	200180	180	14000	220085	85	10000	240050	50	8200
160380	380	42000	180260	260	29000	200190	190	15000	220090	90	10000	240055	55	8300
160390	390	44000	180270	270	32000	200200	200	17000	220095	95	11000	240060	60	8500
160400	400	47000	180280	280	33000	200210	210	19000	220100	100	11000	240065	65	8800
160420	420	53000	180290	290	34000	200220	220	20000	220110	110	12000	240070	70	9200
160450	450	57000	180300	300	35000	200230	230	21000	220120	120	13000	240075	75	9700
160480	480	62000	180310	310	36000	200240	240	22000	220130	130	14000	240080	80	10000
160500	500	65000	180320	320	37000	200250	250	23000	220140	140	15000	240085	85	11000
M18-2.5			180330	330	39000	200260	260	25000	220150	150	16000	240090	90	11000
180025	25	4000	180340	340	42000	200270	270	26000	220160	160	18000	240095	95	12000
180030	30	4000	180350	350	44000	200280	280	28000	220170	170	19000	240100	100	12000
180035	35	4000	180360	360	46000	200290	290	29000	220180	180	20000	240110	110	14000
180040	40	4000	180370	370	52000	200300	300	30000	220190	190	22000	240120	120	15000
180045	45	4000	180380	380	54000	200310	310	36000	220200	200	24000	240130	130	16000
180050	50	4000	180390	390	57000	200320	320	37000	220210	210	28000	240140	140	17000
180055	55	4100	180400	400	60000	200330	330	39000	220220	220	30000	240150	150	18000
180060	60	4300	M20-2.5			200340	340	42000	220230	230	32000	240160	160	20000
180065	65	4500	200030	30	4300	200350	350	44000	220240	240	34000	240170	170	21000
180070	70	4800	200035	35	4300	200360	360	46000	220250	250	36000	240180	180	22000
180075	75	5100	200040	40	4300	200370	370	52000	220260	260	42000	240190	190	24000
180080	80	5400	200045	45	4300	200380	380	54000	220270	270	44000	240200	200	27000
180085	85	5700	200050	50	4300	200390	390	57000	220280	280	46000	240210	210	30000
180090	90	5700	200055	55	4400	200400	400	60000	220290	290	48000	240220	220	31000
180095	95	6200	200060	60	4500	200420	420	65000	220300	300	53000	240230	230	33000
180100	100	6200	200065	65	4600	200450	450	75000	220310	310	54000	240240	240	34000

貨類: 100001

DIN912 公制合金鋼 12.9 級內六角螺絲 (杯頭)

ALLOY STEEL HEX SOCKET HEAD CAP SCREW DIN912-12.9



貨號	規格	售價	貨號	規格	售價	貨號	規格	售價	貨號	規格	售價	貨號	規格	售價	
CODE	SIZE	RMB/1000PCS	CODE	SIZE	RMB/1000PCS	CODE	SIZE	RMB/1000PCS	CODE	SIZE	RMB/1000PCS	CODE	SIZE	RMB/1000PCS	
M24-3.0			M27-3.0			M27-3.0			M30-3.5			M30-3.5			
240250	250	36000	270050	50	14000	270250	250	58000	300080	80	22000	300310	310	77000	
240260	260	38000	270055	55	15000	270260	260	61000	300090	90	24000	300320	320	79000	
240270	270	40000	270060	60	16000	270270	270	63000	300100	100	25000	300330	330	82000	
240280	280	42000	270065	65	17000	270280	280	68000	300110	110	26000	300340	340	84000	
240290	290	44000	270070	70	18000	270290	290	73000	300120	120	28000	300350	350	86000	
240300	300	46000	270075	75	19000	270300	300	75000	300130	130	30000	300360	360	93000	
240310	310	54000	270080	80	20000	270310	310	77000	300140	140	31000	300370	370	95000	
240320	320	56000	270090	90	21000	270320	320	79000	300150	150	33000	300380	380	97000	
240330	330	59000	270100	100	22000	270330	330	82000	300160	160	34000	300390	390	100000	
240340	340	62000	270110	110	23000	270340	340	84000	300170	170	36000	300400	400	110000	
240350	350	64000	270120	120	24000	270350	350	86000	300180	180	38000	300420	420	120000	
240360	360	67000	270130	130	26000	270360	360	93000	300190	190	40000	300450	450	135000	
240370	370	72000	270140	140	28000	270370	370	95000	300200	200	42000	300480	480	150000	
240380	380	76000	270150	150	30000	270380	380	97000	300210	210	48000	300500	500	160000	
240390	390	81000	270160	160	31000	270390	390	100000	300220	220	50000				
240400	400	84000	270170	170	33000	270400	400	110000	300230	230	52000				
240410	410	87000	270180	180	35000				M30-3.5	300240	240	55000			
240420	420	89000	270190	190	36000	300050	50	18000	300250	250	58000				
240430	430	90000	270200	200	38000	300055	55	18000	300260	260	61000				
240440	440	92000	270210	210	43000	300060	60	18000	300270	270	63000				
240450	450	100000	270220	220	47000	300065	65	19000	300280	280	68000				
240480	480	110000	270230	230	51000	300070	70	20000	300290	290	73000				
240500	500	115000	270240	240	55000	300075	75	21000	300300	300	75000				

公制細牙內六角螺絲 (12.9 級)  
HEX SOCKET HEAD CAP SCREW



貨類: 100003

DIN912 公制合金鋼 12.9 級內六角螺絲 (細牙)

ALLOY STEEL HEX SOCKET HEAD CAP SCREW DIN912 FINE THREAD



貨號	規格	售價	貨號	規格	售價	貨號	規格	售價	貨號	規格	售價	貨號	規格	售價
CODE	SIZE	RMB/1000PCS	CODE	SIZE	RMB/1000PCS	CODE	SIZE	RMB/1000PCS	CODE	SIZE	RMB/1000PCS	CODE	SIZE	RMB/1000PCS
M6-0.75			M10-1.0			M14-1.5			M16-1.5			M20-1.5		
060010	10	210	100040	40	1200	140035	35	2400	160150	150	9800	200120	120	16000
060012	12	220	100045	45	1400	140040	40	2600	M18-1.5			200130	130	17000
060016	16	240	100050	50	1500	140045	45	2800	180040	40	8000	200140	140	18000
060020	20	280	100055	55	1600	140050	50	3000	180045	45	8000	200150	150	19000
060025	25	320	100060	60	1700	140055	55	3200	180050	50	8000			
060030	30	360	100065	65	1800	140060	60	3500	180055	55	8200			
060035	35	420	100070	70	1900	140065	65	3700	180060	60	8600			
060040	40	460	100075	75	2000	140070	70	3900	180065	65	9000			
060045	45	500	100080	80	2200	140075	75	4100	180070	70	9600			
060050	50	540	100090	90	2400	140080	80	4400	180075	75	10500			
M8-1.0			100100	100	2700	140090	90	4800	180080	80	11000			
080012	12	440	M12-1.5			140100	100	5200	180090	90	12000			
080016	16	480	120016	16	1300	M16-1.5			180100	100	13000			
080020	20	500	120020	20	1300	160025	25	2900	180110	110	14000			
080025	25	560	120025	25	1400	160030	30	2900	180120	120	15000			
080030	30	620	120030	30	1500	160035	35	3100	180130	130	16000			
080035	35	680	120035	35	1600	160040	40	3300	180140	140	17000			
080040	40	760	120040	40	1700	160045	45	3600	180150	150	18000			
080045	45	840	120045	45	1900	160050	50	3900	M20-1.5					
080050	50	900	120050	50	2000	160055	55	4100	200040	40	8600			
080055	55	980	120055	55	2200	160060	60	4400	200045	45	8600			
080060	60	1100	120060	60	2400	160065	65	4800	200050	50	8600			
080065	65	1200	120065	65	2500	160070	70	5100	200055	55	8800			
080070	70	1300	120070	70	2700	160075	75	5300	200060	60	9000			
M10-1.0			120075	75	2800	160080	80	5600	200065	65	9200			
100016	16	860	120080	80	3000	160090	90	6200	200070	70	9800			
100020	20	860	120090	90	3200	160100	100	6600	200075	75	11000			
100022	22	920	120100	100	3600	160110	110	7200	200080	80	12000			
100025	25	920	M14-1.5			160120	120	7800	200090	90	13000			
100030	30	1000	140025	25	2200	160130	130	8400	200100	100	14000			
100035	35	1100	140030	30	2200	160140	140	8800	200110	110	15000			

貨類: 100002

公制合金鋼 12.9 級全牙內六角螺絲 (杯頭)

ALLOY STEEL HEX SOCKET HEAD CAP SCREW FULL THREAD DIN912-12.9



貨號	規格	售價	貨號	規格	售價	貨號	規格	售價	貨號	規格	售價	貨號	規格	售價
CODE	SIZE	RMB/1000PCS	CODE	SIZE	RMB/1000PCS	CODE	SIZE	RMB/1000PCS	CODE	SIZE	RMB/1000PCS	CODE	SIZE	RMB/1000PCS
M3-0.5			M6-1.0			M10-1.5			M12-1.75			M16-2.0		
030025	25	170	060035	35	290	100045	45	980	120120	120	3300	160120	120	5800
030030	30	200	060040	40	310	100050	50	1050	120130	130	3600	160130	130	6100
030035	35	230	060045	45	350	100055	55	1150	120140	140	3800	160140	140	6600
030040	40	280	060050	50	400	100060	60	1200	120150	150	4100	160150	150	7300
030045	45	330	060055	55	500	100065	65	1300	M14-2.0			M20-2.5		
030050	50	370	060060	60	520	100070	70	1400	140060	60	2650	200075	75	7200
M4-0.7			060065	65	580	100075	75	1450	140065	65	2850	200080	80	7700
040030	30	220	060070	70	630	100080	80	1600	140070	70	3050	200090	90	8100
040035	35	240	060075	75	750	100090	90	1750	140075	75	3200	200100	100	9000
040040	40	270	060080	80	860	100100	100	1900	140080	80	3400	200110	110	9700
040045	45	330	060090	90	980	100110	110	2100	140090	90	3700	200120	120	10500
040050	50	370	060100	100	1100	100120	120	2300	140100	100	4000	200130	130	11000
M5-0.8			M8-1.25			100130	130	2500	140110	110	4400	200140	140	12000
050030	30	220	080040	40	550	100140	140	2800	140120	120	4800	200150	150	13000
050035	35	250	080045	45	610	100150	150	3000	140130	130	5200	M24-3.0		
050040	40	270	080050	50	660	M12-1.75			140140	140	5400	240090	90	16000
050045	45	310	080055	55	750	120055	55	1700	140150	150	5800	240100	100	17000
050050	50	340	080060	60	790	120060	60	1800	M16-2.0			240110	110	18000
050055	55	420	080065	65	870	120065	65	1900	160065	65	3600	240120	120	19500
050060	60	450	080070	70	920	120070	70	2100	160070	70	3800	240130	130	21000
050065	65	490	080075	75	960	120075	75	2200	160075	75	4000	240140	140	22000
050070	70	580	080080	80	1050	120080	80	2300	160080	80	4200	240150	150	23000
050080	80	720	080090	90	1200	120090	90	2500	160090	90	4600			
050090	90	870	080100	100	1400	120100	100	2800	160100	100	5000			
050100	100	1100				120110	110	3100	160110	110	5400			



英制內六角杯頭螺絲 (12.9 級)  
HEX SOCKET HEAD CAP SCREW BS2470



貨類: 100004

BSW 英制合金鋼 12.9 級內六角螺絲 (杯頭)

ALLOY STEEL HEX SOCKET HEAD CAP SCREW BS2470-12.9



貨號	規格	售價	貨號	規格	售價	貨號	規格	售價	貨號	規格	售價	貨號	規格	售價
CODE	SIZE	RMB/1000PCS	CODE	SIZE	RMB/1000PCS	CODE	SIZE	RMB/1000PCS	CODE	SIZE	RMB/1000PCS	CODE	SIZE	RMB/1000PCS
1/8-40			1/4-20			3/8-16			1/2-12			3/4-10		
100020	1/4	88	200200	2"	360	300500	5"	2200	400900	9"	14000	600600	6"	12000
100030	3/8	88	200220	2-1/4	420	300540	5-1/2	2400	401000	10"	15000	600640	6-1/2	15000
100040	1/2	95	200240	2-1/2	460	300600	6"	2650	401100	11"	20000	600700	7"	17000
100050	5/8	100	200260	2-3/4	510	300640	6-1/2	4400	401200	12"	23000	600740	7-1/2	19000
100060	3/4	110	200300	3"	550	300700	7"	4900	5/8-11			600800	8"	19000
100100	1"	130	200320	3-1/4	670	300800	8"	5500	500100	1"	1900	600840	8-1/2	23000
100120	1-1/4	165	200340	3-1/2	760	300900	9"	6500	500120	1-1/4	2000	600900	9"	24000
100140	1-1/2	210	200400	4"	850	301000	10"	7500	500140	1-1/2	2100	601000	10"	26000
100160	1-3/4	230	5/16-18			7/16-14			500160	1-3/4	2300	601100	11"	33000
100200	2"	280	250040	1/2	230	350060	3/4	850	500200	2"	2600	601200	12"	36000
5/32-32			250050	5/8	265	350100	1"	920	500220	2-1/4	2800	7/8-9		
120020	1/4	88	250060	3/4	275	350120	1-1/4	1000	500240	2-1/2	3000	700200	2"	8800
120030	3/8	88	250100	1"	310	350140	1-1/2	1100	500260	2-3/4	3300	700220	2-1/4	9500
120040	1/2	95	250120	1-1/4	360	350160	1-3/4	1200	500300	3"	3500	700240	2-1/2	10000
120050	5/8	100	250140	1-1/2	400	350200	2"	1300	500320	3-1/4	3600	700300	3"	11500
120060	3/4	120	250160	1-3/4	470	350220	2-1/4	1600	500340	3-1/2	4000	700340	3-1/2	13000
120100	1"	135	250200	2"	530	350240	2-1/2	1650	500400	4"	4600	700400	4"	15000
120120	1-1/4	170	250220	2-1/4	570	350260	2-3/4	1900	500440	4-1/2	5600	700440	4-1/2	16000
120140	1-1/2	210	250240	2-1/2	640	350300	3"	2100	500500	5"	6100	700500	5"	18000
120160	1-3/4	230	250260	2-3/4	700	350320	3-1/4	2200	500540	5-1/2	6600	700540	5-1/2	20000
120200	2"	280	250300	3"	790	350340	3-1/2	2400	500600	6"	7400	700600	6"	21000
3/16-24			250320	3-1/4	850	350400	4"	2600	500640	6-1/2	9200	700640	6-1/2	23000
150020	1/4	88	250340	3-1/2	970	1/2-12			500700	7"	9800	700700	7"	24000
150030	3/8	88	250400	4"	1250	400060	3/4	800	500740	7-1/2	10500	700800	8"	28000
150040	1/2	95	250440	4-1/2	1650	400100	1"	1000	500800	8"	11000	700900	9"	38000
150050	5/8	100	250500	5"	2000	400120	1-1/4	1100	500840	8-1/2	16000	701000	10"	42000
150060	3/4	110	250540	5-1/2	2200	400140	1-1/2	1200	500900	9"	18000	701100	11"	48000
150100	1"	135	250600	6"	2300	400160	1-3/4	1300	501000	10"	21000	701200	12"	52000
150120	1-1/4	170	3/8-16			400200	2"	1400	501100	11"	24000	1"-8		
150140	1-1/2	210	300040	1/2	360	400220	2-1/4	1600	501200	12"	26000	800200	2"	14000
150160	1-3/4	240	300050	5/8	360	400240	2-1/2	1700	3/4-10			800240	2-1/2	16000
150200	2"	280	300060	3/4	420	400260	2-3/4	1800	600120	1-1/4	3300	800300	3"	17500
150220	2-1/4	310	300100	1"	470	400300	3"	2000	600140	1-1/2	4000	800340	3-1/2	20000
150240	2-1/2	350	300120	1-1/4	550	400320	3-1/4	2200	600160	1-3/4	4300	800400	4"	21000
150260	2-3/4	440	300140	1-1/2	610	400340	3-1/2	2300	600200	2"	4700	800440	4-1/2	23000
150300	3"	500	300160	1-3/4	680	400400	4"	2500	600220	2-1/4	5000	800500	5"	25000
1/4-20			300200	2"	760	400440	4-1/2	3000	600240	2-1/2	5300	800540	5-1/2	28000
200030	3/8	130	300220	2-1/4	830	400500	5"	3300	600260	2-3/4	5800	800600	6"	30000
200040	1/2	140	300240	2-1/2	930	400540	5-1/2	3800	600300	3"	6200	800640	6-1/2	32000
200050	5/8	160	300260	2-3/4	1050	400600	6"	4000	600320	3-1/4	6600	800700	7"	35000
200060	3/4	170	300300	3"	1150	400640	6-1/2	5200	600340	3-1/2	7000	800800	8"	40000
200100	1"	210	300320	3-1/4	1250	400700	7"	5700	600400	4"	7800	800900	9"	50000
200120	1-1/4	240	300340	3-1/2	1300	400740	7-1/2	6100	600440	4-1/2	8600	801000	10"	54000
200140	1-1/2	270	300400	4"	1500	400800	8"	6300	600500	5"	9500	801100	11"	63000
200160	1-3/4	320	300440	4-1/2	2000	400840	8-1/2	13000	600540	5-1/2	11000	801200	12"	70000



貨類: 100010

台灣內銷標準 12.9 級內六角杯頭螺絲 (英制牙公制頭)  
ALLOY STEEL HEX SOCKET HEAD CAP SCREW NON STANDARD-12.9



貨號	規格	售價	貨號	規格	售價	貨號	規格	售價	貨號	規格	售價
CODE	SIZE	RMB/1000PCS	CODE	SIZE	RMB/1000PCS	CODE	SIZE	RMB/1000PCS	CODE	SIZE	RMB/1000PCS
5/16-18			5/16-18			5/16-18			5/16-18		
250040	1/2	300	250140	1-1/2	520	250260	2-3/4	910	250440	4-1/2	2150
250050	5/8	350	250160	1-3/4	610	250300	3"	1000	250500	5"	2600
250060	3/4	360	250200	2"	690	250320	3-1/4	1100	250540	5-1/2	2800
250100	1"	400	250220	2-1/4	740	250340	3-1/2	1250	250600	6"	3000
250120	1-1/4	470	250240	2-1/2	830	250400	4"	1650			

墊片組合杯頭螺絲 (12.9 級)  
HEX SOCKET HEAD CAP SCREW WITH FLAT WASHER

貨類: 100009

公制合金鋼 12.9 級帶墊片螺絲 (杯頭)  
ALLOY STEEL HEX SOCKET HEAD CAP SCREW DIN912 WITH FLAT WASHER



貨號	規格	售價	貨號	規格	售價	貨號	規格	售價	貨號	規格	售價
CODE	SIZE	RMB/1000PCS	CODE	SIZE	RMB/1000PCS	CODE	SIZE	RMB/1000PCS	CODE	SIZE	RMB/1000PCS
M3-0.5			M5-0.8			M8-1.25			M10-1.5		
030006	6	300	050010	10	340	080012	12	580	100040	40	2400
030008	8	300	050012	12	360	080016	16	960	M12-1.75		
030010	10	300	050016	16	400	080020	20	1000	120016	16	2600
030012	12	320	050020	20	440	080025	25	1100	120020	20	2600
M4-0.7			M6-1.0			080030	30	1200	120025	25	2700
040008	8	320	060010	10	420	M10-1.5			120030	30	2900
040010	10	320	060012	12	440	100016	16	1700	120035	35	3100
040012	12	340	060016	16	480	100020	20	1700	120040	40	3400
040016	16	400	060020	20	560	100025	25	1800	120045	45	3700
M5-0.8			060025	25	640	100030	30	2000	120050	50	4000
050008	8	340	060030	30	720	100035	35	2200			

說明: (1) 以上規格尺寸為常用規格, 備有庫存, 其他規格可根據客戶需求即時生產  
(2) 單墊片螺絲售價比雙墊片螺絲價格-5%

內六角杯頭螺絲 (8.8 級)  
HEX SOCKET HEAD CAP SCREW



貨類: 100201

DIN912 公制 8.8 級內六角杯頭螺絲

ALLOY STEEL HEX SOCKET HEAD CAP SCREW DIN912-8.8



貨號	規格	售價	貨號	規格	售價	貨號	規格	售價	貨號	規格	售價	貨號	規格	售價
CODE	SIZE	RMB/1000PCS	CODE	SIZE	RMB/1000PCS	CODE	SIZE	RMB/1000PCS	CODE	SIZE	RMB/1000PCS	CODE	SIZE	RMB/1000PCS
M3-0.5			M5-0.8			M5-0.8			M6-1.0			M8-1.25		
03006	6	48	05006	6	55	050135	135	1600	060115	115	1100	080100	100	700
03008	8	48	05008	8	55	050140	140	1600	060120	120	1150	080105	105	750
03010	10	48	05010	10	55	050145	145	1800	060125	125	1400	080110	110	750
030012	12	52	050012	12	62	050150	150	1800	060130	130	1400	080115	115	820
030014	14	56	050014	14	65	M6-1.0			060135	135	1500	080120	120	820
030016	16	56	050016	16	65	060008	8	70	060140	140	1500	080125	125	900
030018	18	64	050018	18	68	060010	10	70	060145	145	1800	080130	130	900
030020	20	64	050020	20	70	060012	12	70	060150	150	1800	080135	135	1000
030022	22	70	050022	22	75	060014	14	74	M8-1.25			080140	140	1000
030025	25	70	050025	25	75	060016	16	74	080010	10	126	080145	145	1100
030030	30	78	050030	30	85	060018	18	80	080012	12	132	080150	150	1100
030035	35	86	050035	35	90	060020	20	82	080014	14	140	080160	160	2400
030040	40	98	050040	40	100	060022	22	90	080016	16	140	080170	170	2500
030045	45	115	050045	45	112	060025	25	95	080018	18	150	080180	180	2600
030050	50	135	050050	50	122	060030	30	105	080020	20	150	080190	190	2700
M4-0.7			050055	55	150	060035	35	126	080022	22	160	080200	200	2800
04006	6	52	050060	60	170	060040	40	142	080025	25	170	M10-1.5		
04008	8	52	050065	65	190	060045	45	152	080030	30	190	100016	16	230
04010	10	52	050070	70	200	060050	50	163	080035	35	210	100020	20	250
040010	12	55	050075	75	240	060055	55	190	080040	40	230	100022	22	275
040012	14	60	050080	80	280	060060	60	210	080045	45	260	100025	25	275
040016	16	60	050085	85	340	060065	65	230	080050	50	285	100030	30	300
040018	18	70	050090	90	360	060070	70	260	080055	55	310	100035	35	325
040020	20	70	050095	95	400	060075	75	290	080060	60	330	100040	40	350
020022	22	75	050100	100	450	060080	80	320	080065	65	355	100045	45	390
040025	25	78	050105	105	900	060085	85	400	080070	70	385	100050	50	422
040030	30	90	050110	110	900	060090	90	420	080075	75	425	100055	55	455
040035	35	98	050115	115	1050	060095	95	450	080080	80	485	100060	60	488
040040	40	110	050120	120	1050	060100	100	480	080085	85	530	100065	65	525
040045	45	120	050125	125	1300	060105	105	850	080090	90	600	100070	70	565
040050	50	138	050130	130	1300	060110	110	900	080095	95	660	100075	75	620

貨類: 100201

DIN912 公制 8.8 級內六角杯頭螺絲

ALLOY STEEL HEX SOCKET HEAD CAP SCREW DIN912-8.8



貨號	規格	售價	貨號	規格	售價	貨號	規格	售價	貨號	規格	售價	貨號	規格	售價
CODE	SIZE	RMB/1000PCS	CODE	SIZE	RMB/1000PCS	CODE	SIZE	RMB/1000PCS	CODE	SIZE	RMB/1000PCS	CODE	SIZE	RMB/1000PCS
M10-1.5			M12-1.75			M14-2.0			M16-2.0			M16-2.0		
100080	80	672	120065	65	780	140060	60	1030	160045	45	1150	160230	230	7500
100085	85	730	120070	70	840	140065	65	1100	160050	50	1280	160240	240	8000
100090	90	770	120075	75	900	140070	70	1180	160055	55	1350	160250	250	8500
100095	95	830	120080	80	950	140075	75	1260	160060	60	1450	160260	260	9000
100100	100	880	120085	85	1050	140080	80	1320	160065	65	1550	160270	270	9500
100105	105	1000	120090	90	1050	140085	85	1450	160070	70	1650	160280	280	10000
100110	110	1000	120095	95	1220	140090	90	1500	160075	75	1750	160290	290	10500
100115	115	1150	120100	100	1260	140095	95	1600	160080	80	1850	160300	300	11500
100120	120	1150	120105	105	1430	140100	100	1700	160085	85	1950	160310	310	12000
100125	125	1200	120110	110	1430	140105	105	1900	160090	90	2050	160320	320	12500
100130	130	1200	120115	115	1560	140110	110	2000	160095	95	2200	160330	330	13000
100135	135	1300	120120	120	1560	140115	115	2100	160100	100	2300	160340	340	13500
100140	140	1300	120125	125	1680	140120	120	2200	160105	105	2600	160350	350	14000
100145	145	1400	120130	130	1680	140125	125	2300	160110	110	2700	M18-2.5		
100150	150	1400	120135	135	1950	140130	130	2400	160115	115	2800	180025	25	1800
100160	160	2000	120140	140	1950	140135	135	2500	160120	120	2900	180030	30	1800
100170	170	2200	120145	145	2000	140140	140	2600	160125	125	3000	180035	35	1800
100180	180	2500	120150	150	2050	140145	145	2700	160130	130	3100	180040	40	1800
100190	190	2800	120160	160	2500	140150	150	2800	160135	135	3400	180045	45	1900
100200	200	3200	120170	170	2600	140155	155	2900	160140	140	3500	180050	50	1900
M12-1.75			120180	180	2900	140160	160	3000	160145	145	3600	180055	55	2000
120016	16	420	120190	190	3100	140165	165	3100	160150	150	3800	180060	60	2100
120020	20	420	120200	200	3300	140170	170	3200	160155	155	3900	180065	65	2300
120025	25	440	M14-2.0			140180	180	3500	160160	160	4000	180070	70	2400
120030	30	460	140025	25	650	140190	190	3800	160165	165	4200	180075	75	2500
120035	35	500	140030	30	660	140200	200	4100	160170	170	4300	180080	80	2600
120040	40	540	140035	35	730	M16-2.0			160180	180	5000	180085	85	2800
120045	45	580	140040	40	790	160025	25	850	160190	190	5500	180090	90	2900
120050	50	630	140045	45	830	160030	30	920	160200	200	5600	180095	95	3100
120055	55	680	140050	50	885	160035	35	1000	160210	210	6600	180100	100	3200
120060	60	730	140055	55	950	160040	40	1080	160220	220	7000	180110	110	3500

內六角杯頭螺絲 (8.8 級)  
HEX SOCKET HEAD CAP SCREW



貨類: 100201

DIN912 公制 8.8 級內六角杯頭螺絲

ALLOY STEEL HEX SOCKET HEAD CAP SCREW DIN912-8.8



貨號	規格	售價	貨號	規格	售價	貨號	規格	售價	貨號	規格	售價	貨號	規格	售價
CODE	SIZE	RMB/1000PCS	CODE	SIZE	RMB/1000PCS	CODE	SIZE	RMB/1000PCS	CODE	SIZE	RMB/1000PCS	CODE	SIZE	RMB/1000PCS
M18-2.5			M20-2.5			M20-2.5			M22-2.5			M24-3.0		
180120	120	3700	200060	60	2600	200330	330	20000	220250	250	20000	240200	200	11500
180130	130	4000	200065	65	2700	200340	340	21000	220260	260	21000	240210	210	16000
180140	140	4300	200070	70	2900	200350	350	22000	220270	270	22000	240220	220	17000
180150	150	4900	200075	75	3100	M22-2.5			220280	280	23000	240230	230	18000
180160	160	5300	200080	80	3300	220030	30	3300	220290	290	24000	240240	240	19000
180170	170	5700	200085	85	3500	220035	35	3300	220300	300	25000	240250	250	20000
180180	180	6000	200090	90	3600	220040	40	3300	M24-3.0			240260	260	21000
180190	190	6400	200095	95	3800	220045	45	3500	240030	30	4200	240270	270	22000
180200	200	6800	200100	100	3900	220050	50	3700	240035	35	4200	240280	280	23000
180210	210	9000	200110	110	4200	220055	55	3900	240040	40	4200	240290	290	24000
180220	220	9500	200120	120	4600	220060	60	4100	240045	45	4200	240300	300	25000
180230	230	10000	200130	130	5000	220065	65	4300	240050	50	4200	240310	310	27000
180240	240	10500	200140	140	5300	220070	70	4500	240055	55	4400	240320	320	28000
180250	250	11000	200150	150	5700	220075	75	4700	240060	60	4600	240330	330	29000
180260	260	12000	200160	160	6000	220080	80	4900	240065	65	4800	240340	340	30000
180270	270	13000	200170	170	6400	220090	90	5400	240070	70	5100	240350	350	31000
180280	280	14000	200180	180	6800	220100	100	5900	240075	75	5300	M27-3.0		
180290	290	15000	200190	190	7200	220110	110	6500	240080	80	5600	270060	60	9500
180300	300	16000	200200	200	7600	220120	120	7000	240085	85	5900	270065	65	10000
180310	310	17000	200210	210	10000	220130	130	7400	240090	90	6100	270070	70	10500
180320	320	18000	200220	220	10500	220140	140	7900	240095	95	6400	270075	75	11000
180330	330	19000	200230	230	11000	220150	150	8300	240100	100	6600	270080	80	11500
180340	340	20000	200240	240	11500	220160	160	8800	240110	110	7100	270090	90	12500
180350	350	21000	200250	250	12000	220170	170	9300	240120	120	7700	270100	100	13500
M20-2.5			200260	260	13000	220180	180	9800	240130	130	8000	270110	110	14500
200030	30	2300	200270	270	14000	220190	190	10500	240140	140	8600	270120	120	16000
200035	35	2300	200280	280	15000	220200	200	11000	240150	150	9100	270130	130	17000
200040	40	2300	200290	290	16000	220210	210	16000	240160	160	9600	270140	140	18000
200045	45	2300	200300	300	17000	220220	220	17000	240170	170	10000	270150	150	19000
200050	50	2400	200310	310	18000	220230	230	18000	240180	180	10500	270160	160	20000
200055	55	2500	200320	320	19000	220240	240	19000	240190	190	11000	270170	170	21000

貨類: 100201

DIN912 公制 8.8 級內六角杯頭螺絲

ALLOY STEEL HEX SOCKET HEAD CAP SCREW DIN912-8.8



貨號	規格	售價	貨號	規格	售價	貨號	規格	售價	貨號	規格	售價
CODE	SIZE	RMB/1000PCS	CODE	SIZE	RMB/1000PCS	CODE	SIZE	RMB/1000PCS	CODE	SIZE	RMB/1000PCS
M27-3.0			M30-3.5			M33-3.5			M36-4.0		
270180	180	22000	300210	210	31000	330170	170	35000	360150	150	38000
270190	190	23000	300220	220	32000	330180	180	36000	360160	160	40000
270200	200	24000	300230	230	33000	330190	190	38000	360170	170	42000
270210	210	25000	300240	240	34500	330200	200	40000	360180	180	44000
270220	220	26000	300250	250	35500	330210	210	41000	360190	190	46000
270230	230	28000	300260	260	37000	330220	220	43000	360200	200	48000
270240	240	29000	300270	270	38000	330230	230	45000	360210	210	50000
270250	250	31000	300280	280	39000	330240	240	46000	360220	220	52000
270260	260	32000	300290	290	40500	330250	250	48000	360230	230	53000
270270	270	33000	300300	300	41500	330260	260	50000	360240	240	55000
270280	280	34000	300310	310	43000	330270	270	51000	360250	250	57000
270290	290	36000	300320	320	44000	330280	280	53000	360260	260	59000
270300	300	37000	300330	330	45000	330290	290	54000	360270	270	61000
M30-3.5			300340	340	46500	330300	300	56000	360280	280	63000
300060	60	13000	300350	350	47500	330310	310	61000	360290	290	65000
300065	65	13500	M33-3.5			330320	320	63000	360300	300	67000
300070	70	14000	330050	50	15000	330330	330	65000	360310	310	73000
300075	75	14500	330055	55	16000	330340	340	66000	360320	320	75000
300080	80	15500	330060	60	17000	330350	350	68000	360330	330	77000
300090	90	16500	330065	65	18000	M36-4.0			360340	340	79000
300100	100	17500	330070	70	19000	360060	60	22000	360350	350	81000
300110	110	19000	330075	75	20000	360065	65	23000			
300120	120	20000	330080	80	21000	360070	70	23500			
300130	130	21000	330090	90	22000	360075	75	24000			
300140	140	22500	330100	100	23000	360080	80	25000			
300150	150	24000	330110	110	25000	360090	90	27000			
300160	160	25000	330120	120	26000	360100	100	29000			
300170	170	26000	330130	130	28000	360110	110	31000			
300180	180	27000	330140	140	30000	360120	120	33000			
300190	190	28500	330150	150	31000	360130	130	35000			
300200	200	29500	330160	160	33000	360140	140	37000			



不銹鋼杯頭螺絲  
SUS HEX SOCKET HEAD CAP SCREW Ref. DIN912



貨類: 100701  
公制不銹鋼內六角螺絲 (杯頭)  
SUS HEX SOCKET HEAD CAP SCREW Ref. DIN912



貨號	規格	售價	貨號	規格	售價	貨號	規格	售價	貨號	規格	售價
CODE	SIZE	RMB/1000PCS	CODE	SIZE	RMB/1000PCS	CODE	SIZE	RMB/1000PCS	CODE	SIZE	RMB/1000PCS
M2-0.4			M4-0.7			M6-1.0			M10-1.5		
020004	4	300	040010	10	152	060035	35	513	100025	25	1343
020005	5	300	040012	12	163	060040	40	559	100030	30	1483
020006	6	300	040016	16	188	060045	45	612	100035	35	1627
020008	8	300	040020	20	220	060050	50	661	100040	40	1811
020010	10	300	040025	25	250	060055	55	708	100045	45	1950
020012	12	350	040030	30	285	060060	60	756	100050	50	2084
020016	16	400	040035	35	317	060065	65	800	100055	55	2212
020020	20	450	040040	40	355	060070	70	870	100060	60	2357
M2.5-0.45			040045	45	392	060075	75	920	100065	65	2485
025004	4	300	040050	50	500	060080	80	969	100070	70	2641
025005	5	300	M5-0.8			M8-1.25			100075	75	2770
025006	6	300	050008	8	179	080012	12	615	100080	80	2876
025008	8	300	050010	10	193	080016	16	651	100090	90	3154
025010	10	300	050012	12	208	080020	20	707	100100	100	3427
025012	12	350	050016	16	238	080025	25	821	M12-1.75		
025016	16	400	050020	20	270	080030	30	880	120020	20	1894
025020	20	450	050025	25	308	080035	35	963	120025	25	2088
M3-0.5			050030	30	348	080040	40	1059	120030	30	2266
030006	6	93	050035	35	388	080045	45	1177	120035	35	2436
030008	8	103	050040	40	426	080050	50	1228	120040	40	2651
030010	10	114	050045	45	466	080055	55	1348	120045	45	2900
030012	12	120	050050	50	505	080060	60	1438	120050	50	3038
030016	16	146	050055	55	545	080065	65	1520	120055	55	3259
030020	20	169	050060	60	588	080070	70	1640	120060	60	3464
030025	25	189	M6-1.0			080075	75	1732	120065	65	3660
030030	30	227	060010	10	259	080080	80	1824	120070	70	3856
030035	35	266	060012	12	278	080090	90	1984	120075	75	4056
030040	40	304	060016	16	311	080100	100	2169	120080	80	4257
M4-0.7			060020	20	352	M10-1.5			120090	90	4663
040006	6	131	060025	25	405	100016	16	1107	120100	100	5069
040008	8	139	060030	30	457	100020	20	1204			

貨類: 100702

英制不銹鋼內六角螺絲 (杯頭)

SUS HEX SOCKET HEAD CAP SCREW Ref. BS2470



貨號	規格	售價	貨號	規格	售價	貨號	規格	售價
CODE	SIZE	RMB/1000PCS	CODE	SIZE	RMB/1000PCS	CODE	SIZE	RMB/1000PCS
1/8-40			3/16-24			5/16-18		
100020	1/4	460	150100	1"	1100	250120	1-1/4	2600
100030	3/8	500	150120	1-1/4	1350	250140	1-1/2	2900
100040	1/2	530	150140	1-1/2	1450	250160	1-3/4	3100
100050	5/8	600	1/4-20			250200	2"	3300
100060	3/4	670	200040	1/2	1000	250240	2-1/2	4600
100100	1"	750	200050	5/8	1150	250300	3"	5400
5/32-32			200060	3/4	1280	3/8-16		
120030	3/8	500	200100	1"	1450	300060	3/4	3700
120040	1/2	530	20020	1-1/4	1700	300100	1"	4100
120050	5/8	600	200140	1-1/2	1800	300120	1-1/4	4700
120060	3/4	670	200160	1-3/4	1900	300140	1-1/2	5100
120100	1"	750	200200	2"	2000	300160	1-3/4	5500
3/16-24			5/16-18			300200	2"	5800
150030	3/8	730	250040	1/2	1600	300240	2-1/2	7000
150040	1/2	780	250050	5/8	1800	300300	3"	8300
150050	5/8	880	250060	3/4	2000			
150060	3/4	980	250100	1"	2200			

公制內六角無頭螺絲  
HEX SOCKET HEAD SET SCREW (DIN916)



貨類: 100016

DIN916-45H 公制合金鋼內六角杯尾無頭螺絲 (機米)  
ALLOY STEEL HEX SOCKET SET SCREW DIN916, CUP POINT, Gr. 45H



貨號	規格	售價	貨號	規格	售價	貨號	規格	售價	貨號	規格	售價	貨號	規格	售價
CODE	SIZE	RMB/1000PCS	CODE	SIZE	RMB/1000PCS	CODE	SIZE	RMB/1000PCS	CODE	SIZE	RMB/1000PCS	CODE	SIZE	RMB/1000PCS
M2-0.4			M5-0.8			M8-1.25			M12-1.75			M20-2.5		
020002	2	300	050006	6	26	080050	50	650	120075	75	3500	200045	45	4700
020003	3	300	050008	8	36	080055	55	1050	120080	80	3700	200050	50	5300
020004	4	300	050010	10	46	080060	60	1150	120090	90	4200	200055	55	7500
020005	5	300	050012	12	56	080065	65	1300	120100	100	4700	200060	60	8300
020006	6	300	050016	16	82	080070	70	1400	M14-2.0			200065	65	9300
020008	8	300	050020	20	105	080080	80	1600	140014	14	650	200070	70	10000
020010	10	350	050025	25	160	M10-1.5			140016	16	650	200075	75	11000
020012	12	400	050030	30	190	100008	8	120	140020	20	700	200080	80	12000
M2.5-0.45			050035	35	400	100010	10	120	140025	25	750	200090	90	14000
025002	2	250	050040	40	450	100012	12	130	140030	30	830	200100	100	16000
025003	3	250	050045	45	550	100016	16	195	140035	35	1000	M24-3.0		
025004	4	250	050050	50	650	100020	20	255	140040	40	1200	240025	25	5000
025005	5	250	M6-1.0			100025	25	330	140045	45	1300	240030	30	5500
025006	6	250	060005	5	40	100030	30	400	140050	50	1500	240035	35	5800
025008	8	300	060006	6	33	100035	35	510	140055	55	2300	240040	40	6300
025010	10	350	060008	8	40	100040	40	590	140060	60	2600	240045	45	6600
025012	12	400	060010	10	55	100045	45	750	140065	65	2900	240050	50	7000
M3-0.5			060012	12	70	100050	50	830	140070	70	3300	240055	55	9200
030003	3	24	060016	16	110	100055	55	1700	M16-2.0			240060	60	10000
030004	4	24	060020	20	140	100060	60	1800	160016	16	530	240065	65	11000
030005	5	24	060025	25	180	100065	65	2100	160020	20	660	240070	70	12000
030006	6	24	060030	30	220	100070	70	2200	160025	25	860	240075	75	13000
030008	8	30	060035	35	390	100075	75	2400	160030	30	1100	240080	80	14000
030010	10	35	060040	40	450	100080	80	2600	160035	35	1300	240090	90	15000
030012	12	47	060045	45	550	100090	90	3000	160040	40	1500	240100	100	16000
030016	16	130	060050	50	660	100100	100	3400	160045	45	1800	可根据客户要求订制滚花无头螺絲，价格按上述规格售价+10%		
030020	20	170	060055	55	770	M12-1.75			160050	50	2100			
M4-0.7			060060	60	880	120010	10	200	160055	55	4200			
040003	3	34	060070	70	1100	120012	12	190	160060	60	4600			
040004	4	24	M8-1.25			120016	16	245	160065	65	5100			
040005	5	24	080006	6	72	120020	20	350	160070	70	6600			
040006	6	24	080008	8	55	120025	25	410	160075	75	7200			
040008	8	30	080010	10	70	120030	30	530	160080	80	7700			
040010	10	38	080012	12	88	120035	35	700	160090	90	8600			
040012	12	50	080016	16	130	120040	40	820	160100	100	9500			
040016	16	140	080020	20	190	120045	45	1050	M20-2.5					
040020	20	190	080025	25	230	120050	50	1150	200020	20	2300			
040025	25	240	080030	30	280	120055	55	2400	200025	25	2900			
M5-0.8			080035	35	400	120060	60	2600	200030	30	3200			
050004	4	35	080040	40	450	120065	65	3000	200035	35	3800			
050005	5	24	080045	45	540	120070	70	3200	200040	40	4200			

貨類: 100020

45H 英制合金鋼內六角杯尾無頭螺絲 (機米)

ALLOY STEEL HEX SOCKET SET SCREW BS2470, CUP POINT, Gr. 45H



貨號	規格	售價	貨號	規格	售價	貨號	規格	售價	貨號	規格	售價
CODE	SIZE	RMB/1000PCS	CODE	SIZE	RMB/1000PCS	CODE	SIZE	RMB/1000PCS	CODE	SIZE	RMB/1000PCS
1/8-40			3/16-24			5/16-18			1/2-12		
100010	1/8	56	150100	1"	250	250200	2"	840	400200	2"	1300
100015	3/16	56	1/4-20			250240	2-1/2	1500	400240	2-1/2	3200
100020	1/4	56	200015	3/16	70	250300	3"	2000	400300	3"	3600
100025	5/16	62	200020	1/4	58	3/8-16			5/8-11		
100030	3/8	80	200025	5/16	62	300025	5/16	140	500050	5/8	625
100040	1/2	90	200030	3/8	80	300030	3/8	125	500060	3/4	710
100050	5/8	170	200040	1/2	90	300040	1/2	140	500100	1"	830
100060	3/4	220	200050	5/8	125	300050	5/8	175	500120	1-1/4	1100
5/32-32			200060	3/4	150	300060	3/4	210	500140	1-1/2	1700
120012	5/32	56	200100	1"	180	300100	1"	300	500160	1-3/4	2100
120015	3/16	56	200120	1-1/4	290	300120	1-1/4	400	500200	2"	2500
120020	1/4	56	200140	1-1/2	460	300140	1-1/2	750	500240	2-1/2	5800
120025	5/16	62	200160	1-3/4	620	300160	1-3/4	920	500300	3"	8300
120030	3/8	80	200200	2"	750	300200	2"	1100	3/4-10		
120040	1/2	90	5/16-18			300240	2-1/2	1800	600060	3/4	2700
120050	5/8	170	250020	1/4	90	300300	3"	2300	600100	1"	3200
120060	3/4	210	250025	5/16	80	1/2-12			600120	1-1/4	3500
3/16-24			250030	3/8	83	400030	3/8	250	600140	1-1/2	5000
150015	3/16	56	250040	1/2	110	400040	1/2	210	600160	1-3/4	5800
150020	1/4	56	250050	5/8	140	400050	5/8	260	600200	2"	6600
150025	5/16	62	250060	3/4	180	400060	3/4	330	600240	2-1/2	11000
150030	3/8	80	250100	1"	250	400100	1"	430	600300	3"	13000
150040	1/2	90	250120	1-1/4	320	400120	1-1/4	580			
150050	5/8	170	250140	1-1/2	580	400140	1-1/2	830			
150060	3/4	210	250160	1-3/4	750	400160	1-3/4	1100			

尖端無頭螺絲  
HEX SOCKET HEAD SET SCREW (DIN914)



貨類: 100018

DIN914-45H 公制合金鋼內六角尖端無頭螺絲 (尖端機米)

ALLOY STEEL HEX SOCKET SET SCREW DIN914, CUP POINT, Gr. 45H



貨號	規格	售價	貨號	規格	售價	貨號	規格	售價	貨號	規格	售價
CODE	SIZE	RMB/1000PCS	CODE	SIZE	RMB/1000PCS	CODE	SIZE	RMB/1000PCS	CODE	SIZE	RMB/1000PCS
M2-0.4			M4-0.7			M8-1.25			M12-1.75		
020002	2	250	040008	8	80	080008	8	130	120045	45	2100
020003	3	250	040010	10	100	080010	10	160	120050	50	2400
020004	4	250	040012	12	130	080012	12	200	120055	55	5300
020005	5	250	040016	16	350	080016	16	300	120060	60	5800
020006	6	250	040020	20	480	080020	20	370	120065	65	6500
020008	8	300	M5-0.8			080025	25	480	120070	70	7000
020010	10	350	050004	4	90	080030	30	580	M16-2.0		
020012	12	400	050005	5	60	080035	35	830	160016	16	1200
M2.5-0.45			050006	6	65	080040	40	1000	160020	20	1500
025002	2	250	050008	8	85	080045	45	1200	160025	25	2000
025003	3	250	050010	10	110	080050	50	1500	160030	30	2500
025004	4	250	050012	12	130	M10-1.5			160035	35	3000
025005	5	250	050016	16	200	100008	8	280	160040	40	3500
025006	6	250	050020	20	250	100010	10	240	160045	45	4000
025008	8	300	050025	25	400	100012	12	300	160050	50	4800
025010	10	350	050030	30	470	100016	16	430	160055	55	9500
025012	12	400	M6-1.0			100020	20	550	160060	60	10000
M3-0.5			060005	5	90	100025	25	700	160065	65	12000
030003	3	60	060006	6	75	100030	30	850	160070	70	15000
030004	4	60	060008	8	90	100035	35	1100	M20-2.5		
030005	5	60	060010	10	120	100040	40	1300	200020	20	5500
030006	6	60	060012	12	150	100045	45	1700	200025	25	6700
030008	8	75	060016	16	220	100050	50	1900	200030	30	7500
030010	10	90	060020	20	300	M12-1.75			200035	35	8500
030012	12	120	060025	25	370	120010	10	450	200040	40	9500
030016	16	330	060030	30	500	120012	12	380	200045	45	10000
030020	20	420	060035	35	850	120016	16	550	200050	50	12000
M4-0.7			060040	40	1000	120020	20	700	200055	55	17000
040003	3	85	060045	45	1200	120025	25	930	200060	60	19000
040004	4	60	060050	50	1500	120030	30	1100	200065	65	21000
040005	5	60	M8-1.25			120035	35	1500	200070	70	23000
040006	6	60	080006	6	160	120040	40	1700			



貨類: 100019

DIN913-45H 公制合金鋼內六角平端無頭螺絲 (平端機米)  
ALLOY STEEL HEX SOCKET SET SCREW DIN913, CUP POINT, Gr. 45H



貨號	規格	售價	貨號	規格	售價	貨號	規格	售價	貨號	規格	售價
CODE	SIZE	RMB/1000PCS	CODE	SIZE	RMB/1000PCS	CODE	SIZE	RMB/1000PCS	CODE	SIZE	RMB/1000PCS
M3-0.5			M5-0.8			M8-1.25			M16-2.0		
030003	3	50	050025	25	350	080050	50	1200	160016	16	1000
030004	4	50	050030	30	400	M10-1.5			160020	20	1200
030005	5	50	M6-1.0			100008	8	220	160025	25	1500
030006	6	50	060005	5	70	100010	10	200	160030	30	2000
030008	8	60	060006	6	60	100012	12	250	160035	35	2400
030010	10	70	060008	8	75	100016	16	350	160040	40	2800
030012	12	100	060010	10	95	100020	20	450	160045	45	3200
030016	16	260	060012	12	120	100025	25	550	160050	50	3800
030020	20	340	060016	16	180	100030	30	650	160055	55	8500
M4-0.7			060020	20	250	100035	35	900	160060	60	8500
040003	3	70	060025	25	300	100040	40	1000	160065	65	12000
040004	4	50	060030	30	400	100045	45	1300	160070	70	12000
040005	5	50	060035	35	500	100050	50	1500	M20-2.5		
040006	6	50	060040	40	600	M12-1.75			200020	20	5500
040008	8	60	060045	45	1000	120010	10	360	200025	25	6700
040010	10	76	060050	50	1200	120012	12	300	200030	30	7500
040012	12	100	M8-1.25			120016	16	450	200035	35	8500
040016	16	280	080006	6	150	120020	20	550	200040	40	9500
040020	20	380	080008	8	100	120025	25	750	200045	45	10000
M5-0.8			080010	10	130	120030	30	900	200050	50	12000
050004	4	70	080012	12	160	120035	35	1200	200055	55	19000
050005	5	50	080016	16	230	120040	40	1300	200060	60	19000
050006	6	55	080020	20	300	120045	45	1700	200065	65	23000
050008	8	70	080025	25	380	120050	50	1900	200070	70	23000
050010	10	85	080030	30	460	120055	55	4600			
050012	12	110	080035	35	660	120060	60	4600			
050016	16	160	080040	40	800	120065	65	5600			
050020	20	210	080045	45	960	120070	70	5600			

凸端無頭螺絲  
HEX SOCKET HEAD SET SCREW (DIN915)



貨類: 100017

DIN915-45H 公制合金鋼內六角凸端無頭螺絲 (凸端機米)  
ALLOY STEEL HEX SOCKET SET SCREW DIN915, CUP POINT, Gr. 45H



貨號	規格	售價	貨號	規格	售價	貨號	規格	售價	貨號	規格	售價
CODE	SIZE	RMB/1000PCS	CODE	SIZE	RMB/1000PCS	CODE	SIZE	RMB/1000PCS	CODE	SIZE	RMB/1000PCS
M3-0.5			M5-0.8			M8-1.25			M16-2.0		
030003	3	50	050025	25	350	080050	50	1200	160016	16	1000
030004	4	50	050030	30	400	M10-1.5			160020	20	1200
030005	5	50	M6-1.0			100008	8	220	160025	25	1500
030006	6	50	060005	5	70	100010	10	200	160030	30	2000
030008	8	60	060006	6	60	100012	12	250	160035	35	2400
030010	10	70	060008	8	75	100016	16	350	160040	40	2800
030012	12	100	060010	10	95	100020	20	450	160045	45	3200
030016	16	260	060012	12	120	100025	25	550	160050	50	3800
030020	20	340	060016	16	180	100030	30	650	160055	55	8500
M4-0.7			060020	20	250	100035	35	900	160060	60	8500
040003	3	70	060025	25	300	100040	40	1000	160065	65	12000
040004	4	50	060030	30	400	100045	45	1300	160070	70	12000
040005	5	50	060035	35	500	100050	50	1500	M20-2.5		
040006	6	50	060040	40	600	M12-1.75			200020	20	5500
040008	8	60	060045	45	1000	120010	10	360	200025	25	6700
040010	10	76	060050	50	1200	120012	12	300	200030	30	7500
040012	12	100	M8-1.25			120016	16	450	200035	35	8500
040016	16	280	080006	6	150	120020	20	550	200040	40	9500
040020	20	380	080008	8	100	120025	25	750	200045	45	10000
M5-0.8			080010	10	130	120030	30	900	200050	50	12000
050004	4	70	080012	12	160	120035	35	1200	200055	55	19000
050005	5	50	080016	16	230	120040	40	1300	200060	60	19000
050006	6	55	080020	20	300	120045	45	1700	200065	65	23000
050008	8	70	080025	25	380	120050	50	1900	200070	70	23000
050010	10	85	080030	30	460	120055	55	4600			
050012	12	110	080035	35	660	120060	60	4600			
050016	16	160	080040	40	800	120065	65	5600			
050020	20	210	080045	45	960	120070	70	5600			

貨類: 100706

公制不銹鋼杯尾無頭內六角螺絲 (機米)

SUS HEX SOCKET HEAD SET SCREW



貨號	規格	售價	貨號	規格	售價	貨號	規格	售價	貨號	規格	售價
CODE	SIZE	RMB/1000PCS	CODE	SIZE	RMB/1000PCS	CODE	SIZE	RMB/1000PCS	CODE	SIZE	RMB/1000PCS
M3-0.5			M5-0.8			M8-1.25			M10-1.5		
030003	3	140	050005	5	131	080008	8	235	100035	35	2000
030004	4	140	050006	6	131	080010	10	272	100040	40	2200
030005	5	140	050008	8	145	080012	12	310	M12-1.75		
030006	6	140	050010	10	166	080016	16	379	120012	12	1200
030008	8	168	050012	12	197	080020	20	605	120016	16	1600
030010	10	195	050016	16	236	080025	25	780	120020	20	2000
030012	12	300	050020	20	400	080030	30	927	120025	25	2700
M4-0.7			M6-1.0			080035			120030		
040004	4	122	060006	6	154	080040	40	2000	120035	35	4400
040005	5	122	060008	8	154	M10-1.5			120040	40	5000
040006	6	122	060010	10	179	100010	10	470	120045	45	5500
040008	8	139	060012	12	213	100012	12	527	120050	50	5800
040010	10	150	060016	16	264	100016	16	639			
040012	12	179	060020	20	427	100020	20	989			
040016	16	204	060025	25	537	100025	25	1165			
040020	20	400	060030	30	800	100030	30	1320			

英制不銹鋼杯尾無頭內六角螺絲 (機米)

SUS HEX SOCKET HEAD SET SCREW Ref. BS2470

貨類: 100707

英制不銹鋼杯尾無頭內六角螺絲 (機米)

SUS HEX SOCKET HEAD SET SCREW Ref. BS2470



貨號	規格	售價	貨號	規格	售價	貨號	規格	售價	貨號	規格	售價
CODE	SIZE	RMB/1000PCS	CODE	SIZE	RMB/1000PCS	CODE	SIZE	RMB/1000PCS	CODE	SIZE	RMB/1000PCS
1/8-40			3/16-24			5/16-18			3/8-16		
100010	1/8	320	150015	3/16	320	250025	5/16	530	300140	1-1/2	3600
100015	3/16	320	150020	1/4	320	250030	3/8	620	1/2-12		
100020	1/4	320	150025	5/16	380	250040	1/2	700	400040	1/2	1500
100025	5/16	380	150030	3/8	450	250050	5/8	860	400050	5/8	2000
100030	3/8	450	150040	1/2	520	250060	3/4	1400	400060	3/4	2500
100040	1/2	500	1/4-20			250100	1"	1800	400100	1"	3400
5/32-32			200020	1/4	350	3/8-16			400120	1-1/4	5500
120012	5/32	320	200025	5/16	350	300030	3/8	1100	400140	1-1/2	6300
120015	3/16	320	200030	3/8	410	300040	1/2	1200			
120020	1/4	320	200040	1/2	480	300050	5/8	1500			
120025	5/16	380	200050	5/8	600	300060	3/4	2300			
120030	3/8	450	200060	3/4	1000	300100	1"	2600			
120040	1/2	500	200100	1"	1200	300120	1-1/4	3300			

貨類：100040

10.9 級公制合金鋼平頭內六角螺絲（平杯）

ALLOY STEEL HEX SOCKET FLAT HEAD SCREW DIN7991



貨號	規格	售價	貨號	規格	售價	貨號	規格	售價	貨號	規格	售價	貨號	規格	售價
CODE	SIZE	RMB/100PCS	CODE	SIZE	RMB/100PCS	CODE	SIZE	RMB/100PCS	CODE	SIZE	RMB/100PCS	CODE	SIZE	RMB/100PCS
M2-0.4			M4-0.7			M6-1.0			M10-1.5			M16-2.0		
020003	3	150	040006	6	52	060040	40	210	100045	45	700	160060	60	4000
020004	4	150	040008	8	52	060045	45	250	100050	50	820	160065	65	4200
020005	5	150	040010	10	56	060050	50	290	100055	55	1300	160070	70	4500
020006	6	150	040012	12	68	060055	55	430	100060	60	1600	160075	75	4800
020008	8	150	040016	16	72	060060	60	500	100065	65	1800	160080	80	5200
020010	10	150	040020	20	85	060065	65	580	100070	70	2200	160090	90	5800
020012	12	160	040025	25	115	060070	70	680	100075	75	2400	160100	100	6500
020016	16	190	040030	30	125	M8-1.25			100080	80	2500	M20-2.5		
020020	20	210	040035	35	180	080010	10	190	100090	90	2700	200040	40	7500
M2.5-0.45			040040	40	190	080012	12	190	100100	100	3000	200045	45	8000
025004	4	150	040045	45	230	080016	16	190	M12-1.75			200050	50	8000
025005	5	150	040050	50	280	080020	20	210	120020	20	680	200055	55	8500
025006	6	150	M5-0.8			080025	25	245	120025	25	810	200060	60	9500
025008	8	150	050008	8	58	080030	30	270	120030	30	1000	200065	65	10000
025010	10	150	050010	10	58	080035	35	330	120035	35	1100	200070	70	10000
025012	12	160	050012	12	72	080040	40	370	120040	40	1200	200075	75	11000
025016	16	190	050016	16	80	080045	45	420	120045	45	1350	200080	80	11000
025020	20	210	050020	20	95	080050	50	480	120050	50	1550	200090	90	12000
025025	25	250	050025	25	100	080055	55	650	120055	55	1900	200100	100	13000
025030	30	300	050030	30	140	080060	60	720	120060	60	1900			
M3-0.5			050035	35	190	080065	65	800	120065	65	2100			
030006	6	48	050040	40	210	080070	70	900	120070	70	2300			
030008	8	48	050045	45	240	080075	75	1000	120075	75	2500			
030010	10	48	050050	50	300	080080	80	1100	120080	80	2800			
030012	12	56	M6-1.0			080090	90	1200	120090	90	3100			
030016	16	72	060008	8	80	080100	100	1400	120100	100	3300			
030020	20	85	060010	10	80	M10-1.5			M16-2.0					
030025	25	115	060012	12	80	100016	16	340	160030	30	2400			
030030	30	125	060016	16	90	100020	20	380	160035	35	2700			
030035	35	170	060020	20	105	100025	25	430	160040	40	3000			
030040	40	190	060025	25	125	100030	30	480	160045	45	3200			
030045	45	230	060030	30	145	100035	35	570	160050	50	3300			
030050	50	270	060035	35	180	100040	40	620	160055	55	3600			

貨類: 100041

10.9 級英制合金鋼平頭內六角螺絲 (平杯)

ALLOY STEEL HEX SOCKET FLAT HEAD SCREW BS 2470



貨號	規格	售價	貨號	規格	售價	貨號	規格	售價	貨號	規格	售價
CODE	SIZE	RMB/1000PCS	CODE	SIZE	RMB/1000PCS	CODE	SIZE	RMB/1000PCS	CODE	SIZE	RMB/1000PCS
3/16-24			1/4-20			3/8-16			1/2-12		
150020	1/4	210	200120	1-1/4	500	300050	5/8	600	400200	2"	1700
150030	3/8	210	200140	1-1/2	550	300060	3/4	660	400240	2-1/2	2100
150040	1/2	250	200160	1-3/4	660	300100	1"	730	400300	3"	2600
150050	5/8	270	200200	2"	720	300120	1-1/4	830	400340	3-1/2	3000
150060	3/4	300	5/16-18			300140	1-1/2	1000	400400	4"	3300
150100	1"	350	250040	1/2	430	300160	1-3/4	1300	1/2-13 (美制規格)		
150120	1-1/4	440	250050	5/8	450	300200	2"	1600			
150140	1-1/2	500	250060	3/4	480	300240	2-1/2	2000	400060	3/4	1000
150160	1-3/4	550	250100	1"	550	300300	3"	2500	400100	1"	1200
150200	2"	600	250120	1-1/4	730	1/2-12			400120	1-1/4	1300
1/4-20			250140	1-1/2	830	400060	3/4	1000	400140	1-1/2	1400
200030	3/8	250	250160	1-3/4	1100	400100	1"	1200	400160	1-3/4	1500
200040	1/2	270	250200	2"	1200	400120	1-1/4	1300	400200	2"	1700
200050	5/8	300	250240	2-1/2	1600	400140	1-1/2	1400	400240	2-1/2	2100
200060	3/4	350	250300	3"	1900	400160	1-3/4	1500	400300	3"	2600
200100	1"	380							400400	4"	3300

貨類: 100043

10.9 級公制合金鋼梅花孔螺絲 (平杯)

METRIC STAR TYPE FLAT HEAD CAP SCREW, Gr. 10.9



貨號	規格	售價	貨號	規格	售價	貨號	規格	售價	貨號	規格	售價	貨號	規格	售價
CODE	SIZE	RMB/1000PCS	CODE	SIZE	RMB/1000PCS	CODE	SIZE	RMB/1000PCS	CODE	SIZE	RMB/1000PCS	CODE	SIZE	RMB/1000PCS
M3-0.5			M4-0.7			M5-0.8			M6-1.0			M8-1.25		
030006	6	210	040010	10	240	050016	16	300	060025	25	420	080035	35	1000
030008	8	210	040012	12	290	050020	20	360	060030	30	480	080040	40	1100
030010	10	210	040016	16	300	050025	25	400	060035	35	550	M10-1.5		
030012	12	240	040020	20	360	050030	30	450	M8-1.25			100016	16	1100
030016	16	300	040025	25	400	M6-1.0			080012	12	630	100020	20	1200
030020	20	360	M5-0.8			060010	10	300	080016	16	630	100025	25	1400
M4-0.7			050008	8	230	060012	12	300	080020	20	700	100030	30	1500
040006	6	230	050010	10	230	060016	16	330	080025	25	780	100035	35	1700
040008	8	230	050012	12	270	060020	20	360	080030	30	900	100040	40	1900



不銹鋼平杯螺絲  
SUS HEX SOCKET FLAT HEAD CAP SCREW



貨類: 100715  
公制不銹鋼平頭內六角螺絲 (平杯)  
SUS HEX SOCKET FLAT HEAD CAP SCREW DIN7991



貨號	規格	售價	貨號	規格	售價	貨號	規格	售價	貨號	規格	售價	貨號	規格	售價
CODE	SIZE	RMB/1000PCS	CODE	SIZE	RMB/1000PCS	CODE	SIZE	RMB/1000PCS	CODE	SIZE	RMB/1000PCS	CODE	SIZE	RMB/1000PCS
M2-0.4			M3-0.5			M5-0.8			M8-1.25			M10-1.5		
02004	4	250	030030	30	208	050035	35	284	080040	40	868	100075	75	2413
020005	5	250	030035	35	244	050040	40	325	080045	45	958	100080	80	2556
020006	6	250	030040	40	280	050045	45	359	080050	50	1050	100090	90	2847
020008	8	250	M4-0.7			050050	50	388	080055	55	1141	100100	100	3136
020010	10	250	040006	6	85	M6-1.0			080060	60	1232	M12-1.75		
020012	12	280	040008	8	85	060010	10	190	080065	65	1333	120020	20	1600
020016	16	300	040010	10	97	060012	12	185	080070	70	1424	120025	25	1587
020020	20	350	040012	12	110	060016	16	228	080075	75	1516	120030	30	1755
M2.5-0.45			040016	16	137	060020	20	265	080080	80	1607	120035	35	1939
025004	4	250	040020	20	165	060025	25	316	080090	90	1791	120040	40	2178
025006	6	250	040025	25	200	060030	30	363	080100	100	1973	120045	45	2375
025008	8	250	040030	30	233	060035	35	415	M10-1.5			120050	50	2584
025010	10	250	040035	35	265	060040	40	458	100016	16	900	120055	55	2763
025012	12	280	040040	40	297	060045	45	535	100020	20	898	120060	60	2943
025016	16	300	040045	45	400	060050	50	613	100025	25	964	120065	65	3156
025020	20	350	040050	50	500	060055	55	666	100030	30	1133	120070	70	3370
M3-0.5			M5-0.8			060060	60	714	100035	35	1270	120075	75	3611
030006	6	60	050008	8	120	M8-1.25			100040	40	1444	120080	80	3826
030008	8	61	050010	10	119	080012	12	455	100045	45	1536	120090	90	4256
030010	10	72	050012	12	131	080016	16	455	100050	50	1690	120100	100	4687
030012	12	83	050016	16	160	080020	20	517	100055	55	1836			
030016	16	106	050020	20	196	080025	25	599	100060	60	1969			
030020	20	128	050025	25	233	080030	30	711	100065	65	2116			
030025	25	172	050030	30	251	080035	35	780	100070	70	2251			

貨類: 100044

10.9 級公制合金鋼半圓頭內六角螺絲 (圓杯)

ALLOY STEEL HEX SOCKET BUTTON HEAD SCREW ISO7380



貨號	規格	售價	貨號	規格	售價	貨號	規格	售價	貨號	規格	售價	貨號	規格	售價
CODE	SIZE	RMB/1000PCS	CODE	SIZE	RMB/1000PCS	CODE	SIZE	RMB/1000PCS	CODE	SIZE	RMB/1000PCS	CODE	SIZE	RMB/1000PCS
M2-0.4			M4-0.7			M6-1.0			M10-1.5			M16-2.0		
02003	3	150	04006	6	52	06004	40	240	10045	45	720	16060	60	4700
02004	4	150	04008	8	52	06005	45	300	10050	50	810	16065	65	5000
02005	5	150	04010	10	56	06006	50	350	10055	55	1500	16070	70	5300
02006	6	150	04012	12	68	06005	55	500	10060	60	1600	16075	75	5600
02008	8	150	04016	16	72	06006	60	600	10065	65	2000	16080	80	6000
02010	10	150	04020	20	85	06006	65	650	10070	70	2200	16090	90	6500
02012	12	160	04025	25	115	06007	70	700	10075	75	2400	160100	100	7000
02016	16	190	04030	30	125	M8-1.25			10080	80	2700			
02020	20	210	04035	35	180	08010	10	210	10090	90	2900			
M2.5-0.45			04040	40	190	08012	12	220	10100	100	3100			
02504	4	150	04045	45	230	08016	16	240	M12-1.75					
02505	5	150	04050	50	280	08020	20	260	12020	20	720			
02506	6	150	M5-0.8			08025	25	290	12025	25	830			
02508	8	150	05008	8	67	08030	30	320	12030	30	950			
02510	10	150	05010	10	67	08035	35	370	12035	35	1150			
02512	12	160	05012	12	80	08040	40	400	12040	40	1250			
02516	16	190	05016	16	90	08045	45	450	12045	45	1400			
02520	20	210	05020	20	100	08050	50	500	12050	50	1600			
02525	25	250	05025	25	110	08055	55	640	12055	55	2000			
02530	30	300	05030	30	125	08060	60	750	12060	60	2200			
M3-0.5			05035	35	190	08065	65	850	12065	65	2300			
03006	6	48	05040	40	210	08070	70	950	12070	70	2400			
03008	8	48	05045	45	240	08075	75	1000	12075	75	2500			
03010	10	48	05050	50	300	08080	80	1100	12080	80	3000			
03012	12	56	M6-1.0			08090	90	1200	12090	90	3400			
03016	16	72	06008	8	95	08100	100	1400	120100	100	3800			
03020	20	85	06010	10	95	M10-1.5			M16-2.0					
03025	25	115	06012	12	100	10016	16	380	16030	30	2900			
03030	30	125	06016	16	115	10020	20	420	16035	35	3200			
03035	35	170	06020	20	130	10025	25	470	16040	40	3500			
03040	40	190	06025	25	150	10030	30	500	16045	45	3800			
03045	45	230	06030	30	170	10035	35	580	16050	50	4000			
03050	50	270	06035	35	210	10040	40	630	16055	55	4400			

英制圓杯、梅花孔圓杯螺絲  
HEX SOCKET BUTTON HEAD CAP SCREW



貨類: 100045

10.9 級英制合金鋼半圓頭內六角螺絲 (圓杯)

BS ALLOY STEEL HEX SOCKET BUTTON HEAD CAP SCREW BS 2470



貨號	規格	售價	貨號	規格	售價	貨號	規格	售價	貨號	規格	售價
CODE	SIZE	RMB/1000PCS	CODE	SIZE	RMB/1000PCS	CODE	SIZE	RMB/1000PCS	CODE	SIZE	RMB/1000PCS
3/16-24			1/4-20			3/8-16			1/2-12		
150020	1/4	210	200120	1-1/4	500	300050	5/8	600	400200	2"	1700
150030	3/8	210	200140	1-1/2	550	300060	3/4	660	400240	2-1/2	2200
150040	1/2	250	200160	1-3/4	660	300100	1"	730	400300	3"	2700
150050	5/8	270	200200	2"	720	300120	1-1/4	830	400340	3-1/2	3000
150060	3/4	300	5/16-18			300140	1-1/2	1000	400400	4"	3400
150100	1"	350	250040	1/2	430	300160	1-3/4	1400	1/2-13 (美制規格)		
150120	1-1/4	440	250050	5/8	450	300200	2"	1700	400060	3/4	1000
150140	1-1/2	500	250060	3/4	480	300240	2-1/2	2000	400100	1"	1200
150200	2"	600	250100	1"	550	300300	3"	2400	400120	1-1/4	1300
1/4-20			250120	1-1/4	730	1/2-12			400140	1-1/2	1400
200030	3/8	250	250140	1-1/2	830	400060	3/4	1000	400160	1-3/4	1500
200040	1/2	270	250160	1-3/4	1100	400100	1"	1200	400200	2"	1700
200050	5/8	300	250200	2"	1300	400120	1-1/4	1300	400240	2-1/2	2200
200060	3/4	350	250240	2-1/2	1600	400140	1-1/2	1400	400300	3"	3000
200100	1"	380	250300	3"	1900	400160	1-3/4	1500	400400	4"	3400

### 10.9 級公制合金鋼半圓頭梅花孔螺絲（圓杯）

METRIC STAR TYPE BUTTON HEAD CAP SCREW

貨類：100047

10.9 級公制合金鋼半圓頭梅花孔螺絲（圓杯）

METRIC STAR TYPE BUTTON HEAD CAP SCREW



貨號	規格	售價	貨號	規格	售價	貨號	規格	售價	貨號	規格	售價	貨號	規格	售價
CODE	SIZE	RMB/1000PCS	CODE	SIZE	RMB/1000PCS	CODE	SIZE	RMB/1000PCS	CODE	SIZE	RMB/1000PCS	CODE	SIZE	RMB/1000PCS
M3-0.5			M4-0.7			M5-0.8			M6-1.0			M8-1.25		
030006	6	210	040010	10	240	050016	16	330	060025	25	510	080035	35	1200
030008	8	210	040012	12	290	050020	20	390	060030	30	570	080040	40	1400
030010	10	210	040016	16	300	050025	25	420	060035	35	630	M10-1.5		
030012	12	240	040020	20	360	050030	30	480	M8-1.25			100016	16	1300
030016	16	300	040025	25	390	M6-1.0			080012	12	750	100020	20	1400
030020	20	360	M5-0.8			060010	10	330	080016	16	810	100025	25	1600
M4-0.7			050008	8	260	060012	12	360	080020	20	870	100030	30	1700
040006	6	230	050010	10	260	060016	16	390	080025	25	960	100035	35	1800
040008	8	230	050012	12	300	060020	20	450	080030	30	1100	100040	40	2100

### 10.9 級公制合金鋼半圓頭帶墊片螺絲（圓杯）

METRIC BUTTON HEAD WITH WASHER SCREW

貨類：10048

10.9 級公制合金鋼半圓頭帶墊片螺絲（圓杯）

METRIC BUTTON HEAD WITH WASHER SCREW



貨號	規格	售價	貨號	規格	售價	貨號	規格	售價	貨號	規格	售價	貨號	規格	售價
CODE	SIZE	RMB/1000PCS	CODE	SIZE	RMB/1000PCS	CODE	SIZE	RMB/1000PCS	CODE	SIZE	RMB/1000PCS	CODE	SIZE	RMB/1000PCS
M3-0.5			M4-0.7			M5-0.8			M6-1.0			M8-1.25		
030006	6	180	040010	10	210	050012	12	270	060016	16	390	080020	20	870
030008	8	180	040012	12	260	050016	16	300	060020	20	450	080025	25	960
030010	10	180	040016	16	270	050020	20	350	060025	25	510	080030	30	1050
030012	12	210	M5-0.8			M6-1.0			M8-1.25					
M4-0.7			050008	8	225	060010	10	330	080012	12	750			
040008	8	200	050010	10	225	060012	12	360	080016	16	810			

說明：（1）以上規格尺寸為常用規格，備有庫存，其他規格可根據客戶需求即時生產

（2）單墊片螺絲售價比雙墊片螺絲價格 -5%

公制不銹鋼圓頭內六角螺絲（圓杯）  
SUS HEX SOCKET BUTTON HEAD CAP SCREW Ref. IS07380



貨類: 100718

公制不銹鋼圓頭內六角螺絲（圓杯）

SUS HEX SOCKET BUTTON HEAD CAP SCREW Ref. IS07380



貨號	規格	售價	貨號	規格	售價	貨號	規格	售價	貨號	規格	售價	貨號	規格	售價
CODE	SIZE	RMB/1000PCS	CODE	SIZE	RMB/1000PCS	CODE	SIZE	RMB/1000PCS	CODE	SIZE	RMB/1000PCS	CODE	SIZE	RMB/1000PCS
M3-0.5			M4-0.7			M5-0.8			M8-1.25			M10-1.5		
030006	6	52	040016	16	154	050030	30	319	080012	12	462	100040	40	1586
030008	8	63	040020	20	185	050035	35	362	080016	16	537	100045	45	1740
030010	10	73	040025	25	213	050040	40	401	080020	20	597	100050	50	1893
030012	12	85	040030	30	248	050045	45	441	080025	25	702	M12-1.75		
030016	16	104	040035	35	284	050050	50	482	080030	30	795	120020	20	1699
030020	20	126	040040	40	318	M6-1.0			080035	35	871	120025	25	1849
030025	25	150	040045	45	400	060010	10	196	080040	40	970	120030	30	2093
030030	30	170	040050	50	500	060012	12	223	080045	45	1068	120035	35	2257
030035	35	191	M5-0.8			060016	16	264	080050	50	1166	120040	40	2487
030040	40	212	050008	8	136	060020	20	306	M10-1.5			120045	45	2716
M4-0.7			050010	10	154	060025	25	366	100016	16	903	120050	50	2924
040006	6	76	050012	12	171	060030	30	408	100020	20	1014			
040008	8	99	050016	16	203	060035	35	463	100025	25	1153			
040010	10	116	050020	20	240	060040	40	518	100030	30	1302			
040012	12	123	050025	25	278	060045	45	577	100035	35	1432			



貨類: 100030

公制合金鋼 12.9 級內六角凸肩螺絲 (塞打)

ALLOY STEEL HEX SOCKET HEAD SHOULDER SCREW ISO7379-12.9



貨號	規格	售價	貨號	規格	售價	貨號	規格	售價	貨號	規格	售價	貨號	規格	售價
CODE	SIZE	RMB/1000PCS	CODE	SIZE	RMB/1000PCS	CODE	SIZE	RMB/1000PCS	CODE	SIZE	RMB/1000PCS	CODE	SIZE	RMB/1000PCS
Φ 6.0 <M5-0.8>			Φ 10.0 <M8-1.25>			Φ 12.0 <M10-1.5>			Φ 13.0 <M10-1.5>			Φ 20.0 <M16-2.0>		
060010	10	1350	100016	16	1900	120065	65	4500	130130	130	11000	200035	35	13500
160012	12	1350	100020	20	1900	120070	70	4600	130140	140	12000	200040	40	14000
060016	16	1350	100025	25	2000	120075	75	4800	130150	150	13000	200045	45	14500
060020	20	1350	100030	30	2100	120080	80	4900	130160	160	14000	200050	50	15000
060025	25	1400	100035	35	2200	120085	85	5000	130170	170	15000	200055	55	15500
060030	30	1500	100040	40	2300	120090	90	5100	130180	180	16000	200060	60	16000
060035	35	1600	100045	45	2400	120095	95	5400	130190	190	17000	200065	65	16500
060040	40	1700	100050	50	2500	120100	100	6000	130200	200	18000	200070	70	17000
060045	45	1800	100055	55	2600	120110	110	8500	Φ 16.0 <M12-1.75>			200075	75	17500
060050	50	1900	100060	60	2700	120120	120	9200	160020	20	5100	200080	80	18000
060055	55	2000	100065	65	2900	120130	130	9600	160025	25	5100	200085	85	18500
060060	60	2100	100070	70	3000	120140	140	10000	160030	30	5700	200090	90	19000
060065	65	2200	100075	75	3100	120150	150	11000	160035	35	5900	200095	95	20000
060070	70	2300	100080	80	3200	120160	160	12000	160040	40	6100	200100	100	21000
060075	75	2400	100085	85	3300	120170	170	13000	160045	45	6600	200110	110	22000
060080	80	2500	100090	90	3400	120180	180	14000	160050	50	7200	200120	120	23000
060090	90	2600	100095	95	3600	120190	190	15000	160055	55	7600	200130	130	24000
060100	100	2900	100100	100	3800	120200	200	16000	160060	60	8200	200140	140	26000
Φ 8.0 <M6-1.0>			100110	110	5400	Φ 13.0 <M10-1.5>			160065	65	8700	200150	150	30000
080010	10	1550	100120	120	6000	130016	16	4400	160070	70	9200	200160	160	31000
080012	12	1550	100130	130	6500	130020	20	4400	160075	75	9700	200170	170	32000
080016	16	1550	100140	140	7200	130025	25	4500	160080	80	10500	200180	180	33000
080020	20	1600	100150	150	7500	130030	30	4600	160085	85	11000	200190	190	35000
080025	25	1700	100160	160	8000	130035	35	4900	160090	90	11500	200200	200	37000
080030	30	1850	100170	170	8500	130040	40	5100	160095	95	12000			
080035	35	1950	100180	180	9000	130045	45	5400	160100	100	12500			
080040	40	2000	100190	190	9500	130050	50	5800	160110	110	13500			
080045	45	2100	100200	200	10000	130055	55	5900	160120	120	14000			
080050	50	2200	Φ 12.0 <M10-1.5>			130060	60	6100	160130	130	15000			
080055	55	2300	120016	16	3400	130065	65	6400	160140	140	16000			
080060	60	2400	120020	20	3400	130070	70	6600	160150	150	17000			
080065	65	2600	120025	25	3500	130075	75	6900	160160	160	18000			
080070	70	2800	120030	30	3600	130080	80	7200	160170	170	19000			
080075	75	3100	120035	35	3800	130085	85	7400	160180	180	20000			
080080	80	3300	120040	40	3900	130090	90	7600	160190	190	21000			
080085	85	3500	120045	45	4000	130095	95	8600	160200	200	22000			
080090	90	3700	120050	50	4200	130100	100	9000	Φ 20.0 <M16-2.0>					
080095	95	3900	120055	55	4300	130110	110	9500	200025	25	12000			
080100	100	4000	120060	60	4400	130120	120	10000	200030	30	13000			

英制塞打螺絲  
HEX SOCKET HEAD SHOULDER SCREW



貨類: 100031

英制合金鋼 12.9 級內六角凸肩螺絲 (塞打)

ALLOY STEEL HEX SOCKET HEAD SHOULDER SCREW BS2470-12.9



貨號	規格	售價	貨號	規格	售價	貨號	規格	售價	貨號	規格	售價	貨號	規格	售價
CODE	SIZE	RMB/1000PCS	CODE	SIZE	RMB/1000PCS	CODE	SIZE	RMB/1000PCS	CODE	SIZE	RMB/1000PCS	CODE	SIZE	RMB/1000PCS
Φ 1/4 <3/16-24>			Φ 5/16 <1/4-20>			Φ 3/8 <5/16-18>			Φ 5/8 <1/2-12>			Φ 3/4 <5/8-11>		
200040	1/2	1400	250220	2-1/4	2300	300440	4-1/2	4800	500100	1"	5300	600140	1-1/2	14000
200050	5/8	1400	250240	2-1/2	2400	300500	5"	5400	500120	1-1/4	5900	600160	1-3/4	14500
200060	3/4	1400	250260	2-3/4	2600	Φ 1/2 <3/8-16>			500140	1-1/2	6200	600200	2"	15000
200100	1"	1500	250300	3"	2800	400060	3/4	3500	500160	1-3/4	6400	600220	2-1/4	15500
200120	1-1/4	1600	250320	3-1/4	3100	400100	1"	3700	500200	2"	7000	600240	2-1/2	16000
200140	1-1/2	1700	250340	3-1/2	3500	400120	1-1/4	3800	500220	2-1/4	7500	600260	2-3/4	16500
200160	1-3/4	1800	250400	4"	4000	400140	1-1/2	3900	500240	2-1/2	8000	600300	3"	17000
200200	2"	1900	Φ 3/8 <5/16-18>			400160	1-3/4	4000	500260	2-3/4	8500	600320	3-1/4	18000
200220	2-1/4	2000	300050	5/8	1900	400200	2"	4200	500300	3"	9500	600340	3-1/2	19000
200240	2-1/2	2100	300060	3/4	2000	400220	2-1/4	4300	500320	3-1/4	10500	600400	4"	20000
200260	2-3/4	2300	300100	1"	2100	400240	2-1/2	4400	500340	3-1/2	11000	600440	4-1/2	22000
200300	3"	2400	300120	1-1/4	2200	400260	2-3/4	4600	500400	4"	11500	600500	5"	23000
200340	3-1/2	2700	300140	1-1/2	2300	400300	3"	4800	500440	4-1/2	13500	600540	5-1/2	26000
200400	4"	3000	300160	1-3/4	2400	400320	3-1/4	5100	500500	5"	14000	600600	6"	29000
Φ 5/16 <1/4-20>			300200	2"	2500	400340	3-1/2	5300	500540	5-1/2	15000	600640	6-1/2	30000
250050	5/8	1600	300220	2-1/4	2700	400400	4"	5900	500600	6"	16000	600700	7"	31000
250060	3/4	1600	300240	2-1/2	2800	400440	4-1/2	9000	500640	6-1/2	17000	600740	7-1/2	32000
250100	1"	1700	300260	2-3/4	3000	400500	5"	9500	500700	7"	18000	600800	8"	33000
250120	1-1/4	1900	300300	3"	3100	400540	5-1/2	10000	500740	7-1/2	19000			
250140	1-1/2	2000	300320	3-1/4	3300	400600	6"	11000	500800	8"	20000			
250160	1-3/4	2100	300340	3-1/2	3500	400640	6-1/2	12000	Φ 3/4 <5/8-11>					
250200	2"	2200	300400	4"	3800	400700	7"	13000	600120	1-1/4	13500			

貨類: DIN933: 100055 DIN931: 100056  
DIN933/931 合金鋼 12.9 級高強度外六角螺絲  
HEXAGON BOLT Gr. 12.9 DIN933/931



貨號	規格	售價	貨號	規格	售價	貨號	規格	售價	貨號	規格	售價	貨號	規格	售價
CODE	SIZE	RMB/1000PCS	CODE	SIZE	RMB/1000PCS	CODE	SIZE	RMB/1000PCS	CODE	SIZE	RMB/1000PCS	CODE	SIZE	RMB/1000PCS
M6-1.0			M8-1.25			M12-1.75			M14-2.0			M18-2.5		
060010	10	150	080110	110	1500	120060	60	1700	140150	150	7500	180065	65	5700
060012	12	170	080120	120	1600	120065	65	1800	140160	160	8000	180070	70	6000
060016	16	190	080130	130	1850	120070	70	1900	140170	170	8500	180075	75	6200
060020	20	200	080140	140	2100	120075	75	2000	140180	180	9000	180080	80	6400
060025	25	220	080150	150	2200	120080	80	2150	140190	190	9500	180090	90	7400
060030	30	260	M10-1.5			120090	90	2400	140200	200	10000	180100	100	8000
060035	35	300	100016	16	600	120100	100	2700	M16-2.0			180110	110	8600
060040	40	330	100020	20	640	120110	110	3100	160030	30	2150	180120	120	9100
060045	45	340	100025	25	680	120120	120	3300	160035	35	2200	180130	130	9900
060050	50	370	100030	30	730	120130	130	3600	160040	40	2400	180140	140	10500
060055	55	480	100035	35	770	120140	140	3900	160045	45	2500	180150	150	11000
060060	60	510	100040	40	900	120150	150	4300	160050	50	2600	180160	160	12500
060065	65	560	100045	45	940	120160	160	4900	160055	55	2750	180170	170	13500
060070	70	620	100050	50	1020	120170	170	5200	160060	60	3200	180180	180	14500
060075	75	680	100055	55	1190	120180	180	5400	160065	65	3300	180190	190	15000
060080	80	750	100060	60	1250	120190	190	5500	160070	70	3500	180200	200	16000
060090	90	940	100065	65	1280	120200	200	5600	160075	75	3700	M20-2.5		
060100	100	1100	100070	70	1360	M14-2.0			160080	80	4000	200030	30	4250
M8-1.25			100075	75	1450	140025	25	1700	160090	90	4200	200035	35	4250
080012	12	340	100080	80	1620	140030	30	1700	160100	100	4700	200040	40	4250
080016	16	340	100090	90	1700	140035	35	1750	160110	110	5300	200045	45	4400
080020	20	390	100100	100	1950	140040	40	1850	160120	120	5700	200050	50	4700
080025	25	410	100110	110	2150	140045	45	1950	160130	130	6600	200055	55	5000
080030	30	440	100120	120	2300	140050	50	2150	160140	140	7000	200060	60	5200
080035	35	480	100130	130	2800	140055	55	2350	160150	150	7300	200065	65	5700
080040	40	520	100140	140	3000	140060	60	2500	160160	160	7700	200070	70	6000
080045	45	550	100150	150	3200	140065	65	2550	160170	170	9500	200075	75	6200
080050	50	640	M12-1.75			140070	70	2750	160180	180	9800	200080	80	6400
080055	55	770	120020	20	1000	140075	75	2900	160190	190	11000	200090	90	7400
080060	60	810	120025	25	1050	140080	80	3100	160200	200	11500	200100	100	8000
080065	65	850	120030	30	1100	140090	90	3300	M18-2.5			200110	110	8600
080070	70	900	120035	35	1150	140100	100	3700	180040	40	4250	200120	120	9100
080075	75	940	120040	40	1250	140110	110	4800	180045	45	4400	200130	130	9900
080080	80	980	120045	45	1320	140120	120	5400	180050	50	4700	200140	140	10500
080090	90	1100	120050	50	1450	140130	130	6100	180055	55	5000	200150	150	11000
080100	100	1300	120055	55	1580	140140	140	6500	180060	60	5200			

高強度外六角螺絲 (12.9 級)  
HEXAGON BOLT



貨類: DIN933: 100055 DIN931: 100056  
DIN933/931 合金鋼 12.9 級高強度外六角螺絲  
HEXAGON BOLT Gr. 12.9 DIN933/931



貨號	規格	售價	貨號	規格	售價	貨號	規格	售價	貨號	規格	售價	貨號	規格	售價
CODE	SIZE	RMB/1000PCS	CODE	SIZE	RMB/1000PCS	CODE	SIZE	RMB/1000PCS	CODE	SIZE	RMB/1000PCS	CODE	SIZE	RMB/1000PCS
M20-2.5			M22-2.5			M24-3.0			M27-3.0			M30-3.5		
200160	160	12500	220120	120	15000	240130	130	15500	270120	120	30000	300100	100	26000
200170	170	13500	220130	130	15500	240140	140	16500	270130	130	31000	300110	110	28000
200180	180	14500	220140	140	16500	240150	150	17500	270140	140	32000	300120	120	30000
200190	190	15000	220150	150	17500	240160	160	20000	270150	150	35000	300130	130	31000
200200	200	16000	220160	160	20000	240170	170	22000	270160	160	37000	300140	140	32000
200210	210	19000	220170	170	22000	240180	180	23000	270170	170	40000	300150	150	35000
200220	220	20000	220180	180	23000	240190	190	24000	270180	180	41000	300160	160	37000
200230	230	21000	220190	190	24000	240200	200	25000	270190	190	44000	300170	170	40000
200240	240	22000	220200	200	25000	240210	210	27000	270200	200	46000	300180	180	41000
200250	250	23000	M24-3.0			240220	220	29000	270210	210	49000	300190	190	44000
M22-2.5			240050	50	8000	240230	230	32000	270220	220	52000	300200	200	46000
220050	50	8000	240055	55	8300	240240	240	33000	270230	230	55000	300210	210	49000
220055	55	8300	240060	60	8800	240250	250	34000	270240	240	60000	300220	220	52000
220060	60	8800	240065	65	9200	M27-3.0			270250	250	64000	300230	230	55000
220065	65	9200	240070	70	9600	270060	60	19500	M30-3.5			300240	240	57000
220070	70	9600	240075	75	10000	270065	65	20300	300060	60	20000	300250	250	60000
220075	75	10000	240080	80	10500	270070	70	21000	300065	65	20000			
220080	80	10500	240090	90	12000	270080	80	24000	300070	70	21000			
220090	90	12000	240100	100	13000	270090	90	25000	300075	75	22000			
220100	100	13000	240110	110	14000	270100	100	26000	300080	80	24000			
220110	110	14000	240120	120	15000	270110	110	28000	300090	90	25000			

貨類: 100060  
帶墊片外六角組合螺絲  
HEXAGON BOLT WITH WASHER



貨號	規格	售價	貨號	規格	售價	貨號	規格	售價	貨號	規格	售價
CODE	SIZE	RMB/1000PCS	CODE	SIZE	RMB/1000PCS	CODE	SIZE	RMB/1000PCS	CODE	SIZE	RMB/1000PCS
M6-1.0			M8-1.25			M10-1.5			M12-1.75		
060010	10	450	080012	12	1000	100016	16	1800	120020	20	3000
060012	12	510	080016	16	1000	100020	20	1900	120025	25	3200
060016	16	570	080020	20	1150	100025	25	2050	120030	30	3300
060020	20	600	080025	25	1200	100030	30	2200	120035	35	3500
			080030	30	1300	100035	35	2300	120040	40	3800
						100040	40	2700			



貨類: 101002

UNC 美制合金鋼 8 級內六角螺絲 (杯頭)

ALLOY STEEL HEX SOCKET HEAD CAP SCREW ASME 18. 3-12. 9UNC



貨號	規格	售價	貨號	規格	售價	貨號	規格	售價	貨號	規格	售價	貨號	規格	售價
CODE	SIZE	RMB/1000PCS	CODE	SIZE	RMB/1000PCS	CODE	SIZE	RMB/1000PCS	CODE	SIZE	RMB/1000PCS	CODE	SIZE	RMB/1000PCS
4#-40			1/4-20			3/8-16			5/8-11			7/8-9		
044020	1/4	160	200120	1-1/4	320	300340	3-1/2	1900	500240	2-1/2	4400	700200	2"	13000
044030	3/8	160	200140	1-1/2	380	300400	4"	2100	500260	2-3/4	4700	700220	2-1/4	14000
044040	1/2	170	200160	1-3/4	420	300440	4-1/2	2900	500300	3"	5000	700240	2-1/2	16000
044050	5/8	180	200200	2"	490	300500	5"	3300	500320	3-1/4	5400	700300	3"	17000
044060	3/4	190	200220	2-1/4	550	300540	5-1/2	3700	500340	3-1/2	5900	700340	3-1/2	21000
044100	1"	220	200240	2-1/2	610	300600	6"	4000	500400	4"	6600	700400	4"	23000
6#-32			200260 2-3/4 670			300640 6-1/2 4900			500440 4-1/2 8000			700440 4-1/2 26000		
063020	1/4	160	200300	3"	730	300700	7"	5400	500500	5"	8600	700500	5"	29000
063030	3/8	160	200320	3-1/4	920	300800	8"	6200	500540	5-1/2	9400	700540	5-1/2	31000
063040	1/2	170	200340	3-1/2	1050	300900	9"	7200	500600	6"	11000	700600	6"	33000
063050	5/8	180	200400	4"	1200	301000	10"	8300	500640	6-1/2	13000	700640	6-1/2	39000
063060	3/4	190	5/16-18			1/2-13			500700 7" 14000			700700 7" 42000		
063100	1"	230	250040	1/2	370	400060	3/4	1600	500740	7-1/2	16000	700800	8"	46000
063120	1-1/4	290	250050	5/8	370	400100	1"	1600	500800	8"	17000	700900	9"	61000
063140	1-1/2	360	250060	3/4	390	400120	1-1/4	1700	500900	9"	22000	701000	10"	66000
8#-32			250100 1" 440			400140 1-1/2 1900			501000 10" 24000			701100 11" 80000		
083020	1/4	160	250120	1-1/4	490	400160	1-3/4	2100	501100	11"	26000	701200	12"	86000
083030	3/8	160	250140	1-1/2	560	400200	2"	2200	501200	12"	29000	1"-8		
083040	1/2	170	250160	1-3/4	630	400220	2-1/4	2600	3/4-10			800200	2"	22000
083050	5/8	180	250200	2"	710	400240	2-1/2	2800	600120	1-1/4	5400	800220	2-1/4	22000
083060	3/4	190	250220	2-1/4	800	400260	2-3/4	2900	600140	1-1/2	5400	800240	2-1/2	23000
083100	1"	230	250240	2-1/2	920	400300	3"	3200	600160	1-3/4	5700	800300	3"	26000
083120	1-1/4	290	250260	2-3/4	1000	400320	3-1/4	3400	600200	2"	6200	800340	3-1/2	30000
083140	1-1/2	360	250300	3"	1100	400340	3-1/2	3700	600220	2-1/4	6700	800400	4"	33000
10#-24			250320 3-1/4 1400			400400 4" 4100			600240 2-1/2 7200			800440 4-1/2 35000		
102030	3/8	160	250340	3-1/2	1500	400440	4-1/2	5200	600260	2-3/4	7600	800500	5"	39000
102040	1/2	170	250400	4"	1800	400500	5"	5500	600300	3"	8500	800540	5-1/2	44000
102050	5/8	180	250400	4-1/2	2100	400540	5-1/2	6400	600320	3-1/4	9200	800600	6"	47000
102060	3/4	190	240500	5"	2500	400600	6"	6600	600340	3-1/2	9800	800640	6-1/2	51000
102100	1"	230	250540	5-1/2	2700	400640	6-1/2	8300	600400	4"	11000	800700	7"	55000
102120	1-1/4	280	250600	6"	2700	400700	7"	9200	600440	4-1/2	12000	800800	8"	62000
102140	1-1/2	340	3/8-16			400740 7-1/2 9700			600500 5" 14000			800900 9" 81000		
102160	1-3/4	390	300050	5/8	540	400800	8"	10500	600540	5-1/2	15000	801000	10"	94000
102200	2"	430	300060	3/4	580	400900	9"	15500	600600	6"	18000	801100	11"	100000
102220	2-1/4	480	300100	1"	680	401000	10"	17000	600640	6-1/2	20000	801200	12"	110000
102240	2-1/2	550	300120	1-1/4	770	401100	11"	22000	600700	7"	22000			
102260	2-3/4	610	300140	1-1/2	860	401200	12"	25000	600740	7-1/2	23000			
102300	3"	770	300160	1-3/4	1000	5/8-11			600800 8" 24000					
1/4-20			300200 2" 1100			500100 1" 2800			600900 9" 33000					
200030	3/8	180	300220	2-1/4	1200	500120	1-1/4	2900	601000	10"	35000			
200040	1/2	200	300240	2-1/2	1400	500140	1-1/2	3300	601100	11"	39000			
200050	5/8	220	300260	2-3/4	1500	500160	1-3/4	3500	601200	12"	42000			
200060	3/4	230	300300	3"	1600	500200	2"	3800						
200100	1"	280	300320	3-1/4	1700	500220	2-1/4	4100						